

KYRA

User's Manual



Copyright

All rights reserved. Permission to reprint or electronically reproduce any document or graphic in whole or in part for any reason is expressly prohibited, unless prior written consent is obtained from the DirectOut GmbH.

All trademarks and registered trademarks belong to their respective owners. It cannot be guaranteed that all product names, products, trademarks, requisitions, regulations, guidelines, specifications and norms are free from trade mark rights of third parties.

All entries in this document have been thoroughly checked; however no guarantee for correctness can be given.

DirectOut GmbH cannot be held responsible for any misleading or incorrect information provided throughout this manual.

DirectOut GmbH reserves the right to change specifications at any time without notice.

DirectOut Technologies® is a registered trademark of the DirectOut GmbH.

© DirectOut GmbH, 2016

Table of contents

About This Manual	5
How to Use This Manual.....	5
Conventions	5
CHAPTER 1: Overview	6
Introduction	6
Feature Summary.....	6
How it works	6
Applications.....	7
CHAPTER 2: Legal issues & facts	8
Before Installing This Device	8
Defective Parts/Modules	8
First Aid (in case of electric shock).....	9
Updates	10
Conditions of Warranty	10
Intended Operation	10
Conformity & Certificates	11
Contact.....	11
Contents.....	12
Accessory.....	12
CHAPTER 3: Installation	14
Installing the Device	14
CHAPTER 4: Operation	18
Global Control.....	18
Introduction	18
Input Selection	19
Channel Selection	20
Mix Level / Master Volume Setting.....	22
Monitoring.....	24
Signal Input / Output	25
Servicing / Remote Control	26
Channel Lock	27
Factory Reset	27
CHAPTER 5: Troubleshooting and Maintenance	29
Troubleshooting.....	29
Maintenance.....	29
CHAPTER 6: Technical Data	30
Appendix A: Wiring AES I/O, Line Out	32
DSUB-9 (female)	32
Index	33

About This Manual

How to Use This Manual

This manual guides you through the installation and operation of the device. Use the Table of Contents at the beginning of the manual or Index Directory at the end of the document to locate help on a particular topic. You can access more information and latest news by visiting on the DirectOut website at www.directout.eu.

Conventions

The following symbols are used to draw your attention to:

TIPS!

indicate useful hints and shortcuts.



NOTES!

are used for important points of clarification or cross references.



WARNINGS!

alert you when an action should always be observed.



CHAPTER 1: Overview

Introduction

Welcome to KYRA, DirectOut’s monitoring device for signal control in MADI environments. KYRA provides three MADI inputs and outputs, an analog stereo line out and an AES I/O. Up to four stereo or eight mono channels can be summed with individual levels onto a main mix. The main mix is output by the integrated speakers and the other outputs.



Feature Summary

MADI Ports	1 x SC multi-mode connectors 1 x SFP (empty cage without module) 1 x coaxial BNC connectors with PFT technology (power fail through)
MADI Formats	56/64 channel, 48k/96k Frame
Sample Rates	44.1, 48, 88.2, 96 kHz +/-12.5%
AES Port	1 x AES3 I/O (DSUB-9)
Line Output	1 x stereo, balanced, +24 dBu (DSUB-9)
Speaker	2 x speakers
Headphone Output	6.3 mm TRS jack, stereo, +18 dBu
USB Port	USB 2.0 port for firmware updates and remote control.
Power Supply	This device is equipped with one wide range power supply (84 V to 264 V AC / 47 Hz to 63 Hz / safety class 1)

How it works

A channel pair or two single mono channels are selected via the source panel. Each of the four source panels can be configured to either stereo or mono. The mono channels for left and right are summed with individual levels (mix level) onto the main mix (stereo). The volume (master volume) of the four outputs (speakers, line out, phones, AES out) is adjusted (or muted) individually. The channel selection can be locked against unwanted modification.

Applications

KYRA can be used for monitoring, line checking and mixing of digital signals.

Typical applications include:

- creation of individual monitor feeds for commentators
- flexible signal control of a MADI or AES signal
- basic mix of 4 stereo or eight mono channels
- format conversion of a MADI signal (SFP <> SC <> BNC)
- signal distribution (routing matrix) [in a future release]
- ...

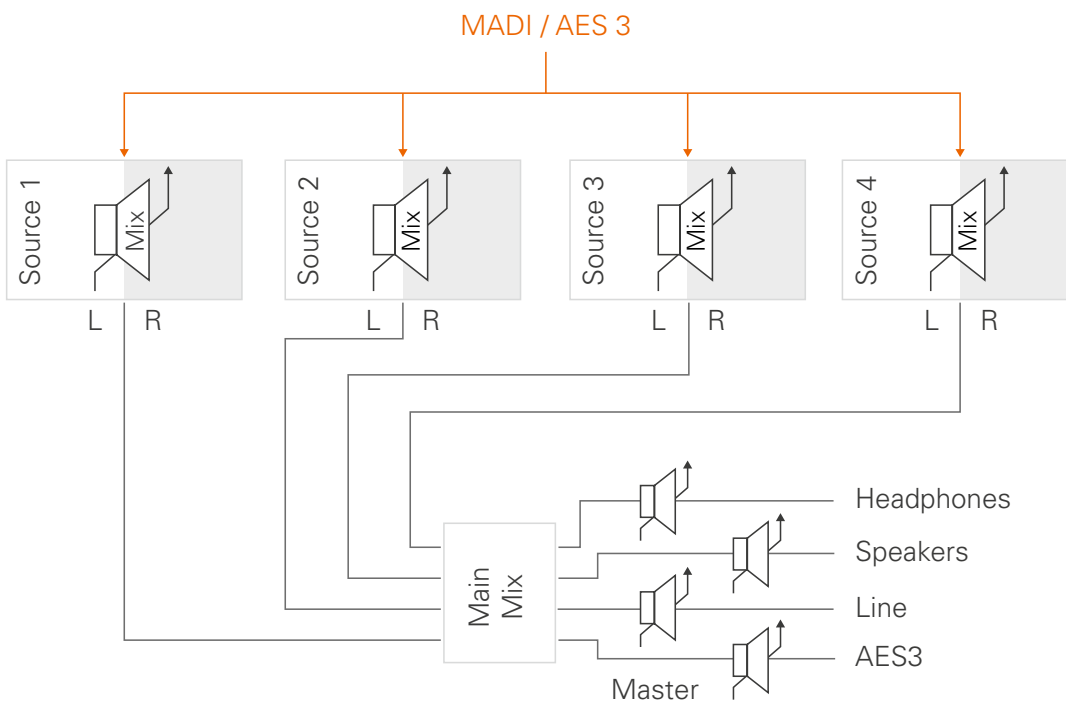

CHAPTER 2: Legal issues & facts

Before Installing This Device



WARNING!

Please read and observe all of the following notes before installing this product:

- Check the hardware device for transport damage.
- Any devices showing signs of mechanical damage or damage from the spillage of liquids must not be connected to the mains supply, or disconnected from the mains immediately by pulling out the power lead.
- All devices must be grounded. The device is grounded through its IEC power connections.
- All devices must be connected to the mains using the three-cord power leads supplied with the system. Only supply electrical interfaces with the voltages and signals described in these instructions.
- Do not use the device at extreme temperatures. Proper operation can only be guaranteed between temperatures of 5° C and 45° C and a maximum relative humidity of 80 %, non-condensing.
- The cabinet of the device will heat up. Do not place the device close to heating sources (e.g. heaters). Observe the environmental conditions.

Defective Parts/Modules



WARNING!

This device contains no user-serviceable parts. Therefore do not open the device. In the event of a hardware defect, please send the device to your DirectOut representative together with a detailed description of the fault.

We would like to remind you to please check carefully whether the failure is caused by erroneous configuration, operation or connection before sending parts for repair.

First Aid (in case of electric shock)

WARNING!



- Do not touch the person or his/her clothing before power is turned off, otherwise you risk sustaining an electric shock yourself.
- Separate the person as quickly as possible from the electric power source as follows:
 - Switch off the equipment.
 - Unplug or disconnect the mains cable.
- Move the person away from the power source by using dry insulating material (such as wood or plastic).
- If the person is unconscious:
 - Check their pulse and reanimate if their respiration is poor.
 - Lay the body down and turn it to one side. Call for a doctor immediately.
- Having sustained an electric shock, always consult a doctor.

Updates

DirectOut products are continually in development, and therefore the information in this manual may be superseded by new releases. To access the latest documentation, please visit the DirectOut website:

www.directout.eu.

This guide refers to firmware version 1.7.

Intended Operation

The KYRA is designed for monitoring and mixing of digital audio signals. In this context digital audio refers to a MAD1 signal (AES10) and an AES signal (AES3).



WARNING!

No compensation can be claimed for damages caused by operation of this unit other than for the intended use described above. Consecutive damages are also excluded explicitly. The general terms and conditions of business of DirectOut GmbH are applied.

Conditions of Warranty

This unit has been designed and examined carefully by the manufacturer and complies with actual norms and directives.

Warranty is granted by DirectOut GmbH over the period of two years for all components that are essential for proper and intended operation of the device. The date of purchase is applied for this period.

Consumable parts (e.g. battery) are excluded from warranty claims.



WARNING!

All claims of warranty will expire once the device has been opened or modified, or if instructions and warnings were ignored.

For warranty claims please contact the dealer where your device was acquired.

Conformity & Certificates

CE

This device complies with the basic requests of applicable EU guidelines. The appropriate procedure for approval has been carried out.

RoHS

(Restriction of the use of certain Hazardous Substances)

This device was constructed fulfilling the directive on the restriction of the use of certain hazardous substances in electrical and electronic equipment 2002/95/EC.

WEEE

(Directive on Waste Electrical and Electronic Equipment)

Due to the directive 2002/96/EC for waste disposal this device must be recycled.

For correct recycling please dispatch the device to:

DirectOut GmbH,
Leipziger Str. 32
09648 Mittweida
Germany

Only stamped parcels will be accepted!

WEEE-Reg.-No. DE 64879540

Contact

DirectOut GmbH
Leipziger Str. 32, 09648 Mittweida, Germany
Phone: +49 (0)3727 5665-100
Fax: +49 (0)3727 5665-101
Mail: sales@directout.eu
www.directout.eu

Contents

The contents of your KYRA package should include:

- 1 x KYRA (19", 1 RU)
- 1 x power chord
- 1 x fixing unit for power plug
- 1 x Manual

To complete the delivery please download from the

DirectOut website: www.directout.eu/en/support/downloads/kyra.html

- USB Serial driver

Accessory

The Line Out and AES3 I/O are available as a DSUB-9 socket. For adaption between DSUB-9 and XLR plugs an adaptor is offered optionally.



DSUB-9 to XLR adaptor

Signal	XLR
Line Out L	female
Line Out R	female
AES3 input	male
AES3 output	male

Pinout DSUB-9: see „Appendix A: Wiring AES I/O, Line Out“ on page 32

Two different optical SFP modules are available from DirectOut GmbH:

- Multimode SFP transceiver with LC connectors (No: 11900-129)
- Singlemode SFP transceiver with LC connectors (No: 11900-130)

Specification of the optical SFP modules:

SFP	Multimode	Singlemode
Wavelength TX	1310 nm	1310 nm
Wavelength RX	1310 nm	1310 nm
Distance	2 km	10 km
Powerbudget (dB)	11 dB	12 dB
Protocols	Fast Ethernet OC3/STM1	Gigabit Ethernet, Gigabit Fibre Channel
Bandwidth from	100 Mbit/s	1.050 Gbit/s
Bandwidth	155 Mbit/s	1.250 Gbit/s
Laser	FP	FP
Receiver Type	PIN	PIN
Connector	LC	LC
Wavelength TX min	1260 nm	1260 nm
Wavelength TX max	1360 nm	1360 nm
Wavelength RX min	1260 nm	1260 nm
Wavelength RX max	1620 nm	1600 nm
Transmit min	- 19.00 dBm	- 9.00 dBm
Transmit max	- 14.00 dBm	- 3.00 dBm
Receive min	- 30 dBm	- 21.00 dBm
Receive max (Receiver overload)	- 5.00 dBm	- 3.00 dBm
Temperature (min)	0° Celsius	0° Celsius
Temperature (max)	70° Celsius	70° Celsius
Type of DDM/DOM	internal	internal
Extinction Ratio	8.20 dB	9 dB

CHAPTER 3: Installation

Installing the Device

1. Open the packaging and check that the contents have been delivered complete and undamaged.
2. Fix the device in a 19" frame with four screws, or place it on a non-slip horizontal surface.



WARNING!

Avoid damage from condensation by waiting for the device to adapt to the environmental temperature. Proper operation can only be guaranteed between temperatures of 5° C and 45° C and a maximum relative humidity of 80%, non-condensing. Ensure that the unit has sufficient air circulation for cooling.

3. Remove the protective cap from the optical MADI port(s) before use.



NOTE!

Retain the protective cap if the optical port is unused. This will protect against soiling which can lead to malfunction.

4. Connect signal cable(s) for the MADI signals.



5. Connect the signal cables for the analog and AES3 audio signals to the DSUB-9 adaptor. Connect the adaptor to the DSUB-9 plug at the rear panel.

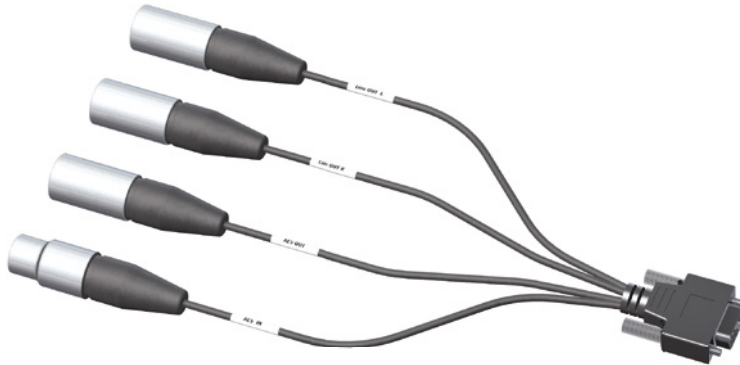

The adaptor converts from DSUB-9 (male) to:

- 2 x XLR male (Line Out L/R)
- 1 x XLR male (AES3 output)
- 1 x XLR female (AES3 input).



WARNING!



Do not connect voltage sources to the analog outputs. This may cause damage at the output stages. Observe the technical specifications listed in this document.

6. Optional: Connect an USB cable to the USB port for remote control or firmware updates. This requires the USB Serial driver (Windows) being installed first. The driver and the installation instructions are available at www.directout.eu.

Link: <http://www.directout.eu/en/support/downloads/kyra.html>

7. Using the power cord provided connect the PSU to a matching power supply:



WARNING!

This device must be connected to the mains using the three-cord power leads supplied with the system. Only supply the voltages and signals indicated (84 V – 264 V).

8. Turn on the power switch:



While the device is booting the currently installed firmware is indicated by source panels 1 and 2- e.g. firmware version 1.7.



TIP!

Use the DirectOut Release Map to match your DirectOut device with the latest firmware or software release.

Link: http://www.directout.eu/upload/dokumente/dotec_release_map.pdf



NOTE!

To update the firmware an installed USB Serial driver (Windows) and the Update Tool are necessary. The software and the installation instructions are available at www.directout.eu.

TIP!



Keep any packaging in order to protect the device should it need to be dispatched for service.

9. Installation of USB Serial driver

- download the USB Serial driver
- download the 'Installation Guide for USB Control'
 - Link: <http://www.directout.eu/en/support/downloads/kyra.html>
- follow the installation instructions in the 'Installation Guide for USB Control'

CHAPTER 4: Operation

Introduction

This chapter describes the basic operation of the device.

Note that throughout this manual, the abbreviation FS refers to sample rate or sample frequency. So, when dealing with scaling factors, the following sample rates can be written as:

- 44.1 kHz or 48 kHz = 1 FS
- 88.2 kHz or 96 kHz = 2 FS
- 176.4 kHz or 192 kHz = 4 FS

Global Control

The power switch is on the back panel:



Power	1 Switch Enable / disable power supply.
Power	C13 socket Connect the power supply here (84- 264 V AC).



NOTE!

Unlit leds at the front panel do not guarantee that the device is free of voltage. To ensure that the device is completely disconnected from mains voltage, the power chords must be disconnected.

Input Selection

One of the three MADi inputs is used as a input source.

Selection priority of locked inputs: BNC > SC > SFP

The selection state is indicated by two LEDs. The AES input is available as separate source in each source panel.



Selected MADi Input	LED BNC (green)	LED SC (green)
BNC	ON	OFF
SC	OFF	ON
SFP	ON	ON
no signal lock	OFF	OFF

The MADi input is used as sync source for the device. The AES input is used as clock source only if no MADi input signal is present.

The channel mode (56ch <> 64ch) is detected automatically.

All MADi outputs carry the signal of the selected MADi input.

The device will switch to 2 FS operation automatically when a 96k Frame signal has been detected.

Channel Selection

The upper part of the four source panels each provides access to the individual channels of the MADi signal or the AES input.



Each source panel can be set individually to stereo or mono mode:

Stereo: a channel pair is used- e.g. channel <03> & <04>.

The mix level setting is applied to both channels.

Mono: individual channels for left and right are selectable- e.g. channel <03> & <26>. The mix level setting is applied to each channel individually.

In mono mode the right channel can be set to 'link' (<_L>) to copy channel selection and mix level from left to right channel e.g. <03> & <_L>. All four source panels are operated identically.

<p>1 2 'Source Channel'</p>	<p>2 x 5 LEDs (green) indicate channel mode and input signal level.</p>  <p>Mono Left Mono Right Stereo</p> <p>The first LED in each channel LED field shows the selection of mono left / mono right / stereo. The other four LEDs show the input signal level of the selected audio channel (only left or right in mono mode).</p>
<p>Display</p>	<p>2 x 7 Segment Display to indicate channel selection and level setting.*</p>
<p>Channel Mono/Stereo</p>	<p>Encoder to select channel and toggle channel mode.**</p> <p>Turn to select the channel for monitoring. Push short to toggle between left and right channel in mono mode. Push longer than 2 s to toggle between mono and stereo mode.</p>

* In idle state or while turning the upper encoder the display informs about the selected channel pair (stereo) or the selected single channels (mono). While turning the level encoder the display changes to the level setting.

** As soon as an encoder is pushed, a decimal point lights up in the display.

Channel Display Values

Code	Function
<empty>	no source selected
01 .. 64	MADI channels 01 to 64 (in stereo mode, only odd numbers are selectable, source channels are odd/even for left/right)
A1	AES left channel
A2	AES right channel
A_	AES stereo
_L	Link (only available for right channel in mono mode, channel and volume settings are then copied from left channel)

Level Display

Input level in mono mode, right channel

LED	Level range
	less than -48 dBFS
	> -48 dBFS
	> -24 dBFS
	> -12 dBFS
	> -6 dBFS

NOTE!

The channel settings can be locked- see "Channel Lock" on page 27.





Mix Level / Master Volume Setting

The lower part of each source panels provides access to the particular mixing level and the output master volume. Mix level refers to the source in the main mix, Master volume refers to main mix at the outputs (Phones, AES, Line, Speakers).



All four source panels are operated identically.

<p>Mix <Output> (Phones, AES, Line, Speakers) , Volume Bar'</p>	<p>2 x 5 LEDs (green) indicate mix level or master volume.</p> <div style="display: flex; justify-content: space-around; align-items: center;"> <div style="text-align: center;">  <p>Mix level</p> </div> <div style="text-align: center;">  <p>Master volume</p> </div> </div> <p>The first LED in each channel LED field shows the selection of mix or master. The other four LEDs show the level/volume value.</p>
<p>Display</p>	<p>2 x 7 Segment Display to indicate channel selection and level setting.*</p>
<p>Level Mix/<Output> (Phones, AES, Line, Speakers)</p>	<p>Encoder to select channel and toggle channel mode.**</p> <p>Turn to change level or to release mute. Push short to toggle mute. Push longer than 2 s to toggle between mix and master.</p>

* In idle state or while turning the upper encoder the display informs about the selected channel pair (stereo) or the selected single channels (mono). While turning the level encoder the display changes to the level setting.

** As soon as an encoder is pushed, a decimal point lights up in the display.

Muting:

- Mute is not stored, all mutes are off when switching the device on.
- Mutes are separate parameters for mix level and master volume.
- Mute is displayed by blinking of the volume bar and blinking of the source channel LEDs.

WARNING





Toggling <Mute> may result in abrupt changes of loudness.

Level/Volume Display Values

Code	Function
00	mute
01 .. 99	volume in 1 dB steps from (-100 + value) dBFS
+0 .. +9	0 to +9 dBFS

Level/Volume Display

Output master volume

LED	level/volume range
	mute
	-99 to -50 dBFS
	-49 to -24 dBFS
	-23 to 0 dBFS
	+1 to +9 dBFS

Monitoring

Four output sinks with individual volume settings are available:

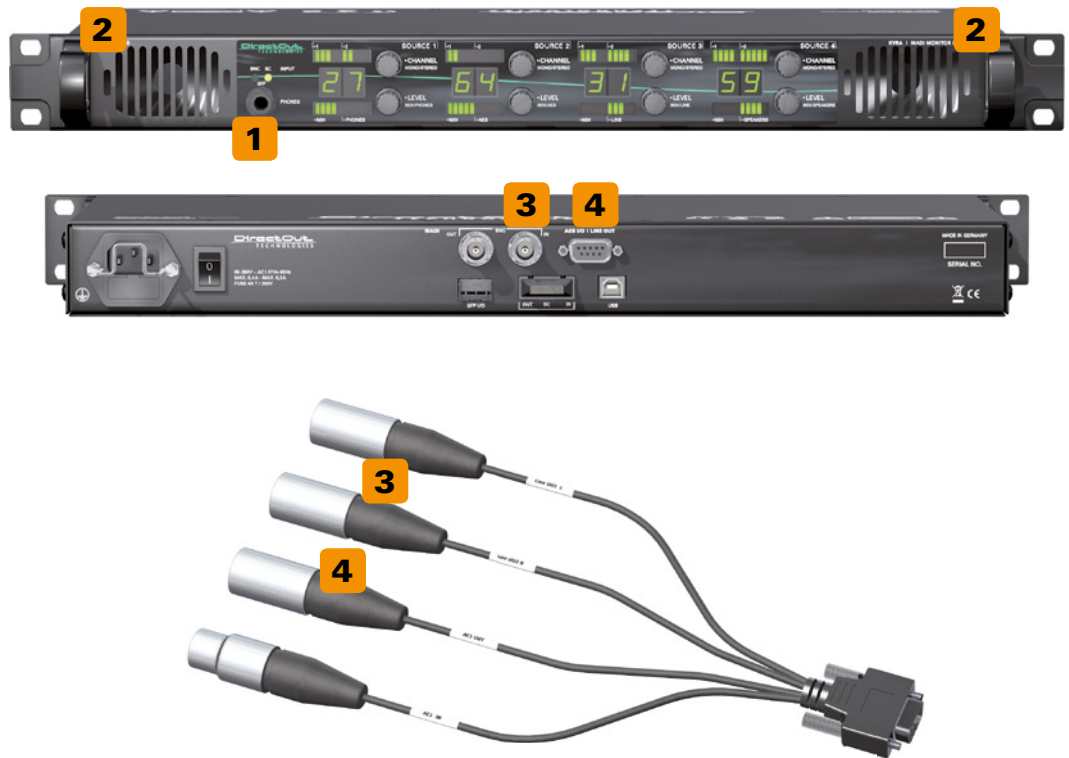

<p>1 Phones</p>	<p>6.3 mm TRS jack, stereo Connect the headphones here to monitor the main mix.</p>
<p>2 Speakers</p>	<p>2 x speakers for monitoring of the main mix</p>
<p>3 Line Out</p>	<p>2 x XLR connector (female) Requires connected DSUB-9 adaptor at the rear panel.</p>
<p>4 AES Out</p>	<p>1 x XLR connector (female) Requires connected DSUB-9 adaptor at the rear panel.</p>

Signal Input / Output



<p>1 BNC OUT / IN</p>	<p>2 x BNC socket (coaxial) OUT: MAD1 output (64 ch), connect for MAD1 output signal here. IN: MAD1 input (64 ch), connect MAD1 input signal here.</p>
<p>2 SFP</p>	<p>1 x SFP cage* Insert SFP module here and connect MAD1 input/output</p>
<p>3 SC OUT / IN</p>	<p>2 x SC socket (optical) OUT: MAD1 output (64 ch), connect for MAD1 output signal here. IN: MAD1 input (64 ch), connect MAD1 input signal here.</p>
<p>4 AES I/O LINE OUT</p>	<p>1 x DSUB-9 connector (female) Connect DSUB-9 adaptor here for XLR connection of AES I/O and Line Out.</p>

- * empty cage, module not included in delivery
 All MAD1 outputs carry the signal of the selected MAD1 input.

Power Fail Through (PFT)

The coaxial I/O maintains the signal transmission from BNC input to BNC output in case of a power loss.

WARNING!

Only use the original adaptor or observe correct pin assignment- see "Appendix A: Wiring AES I/O, Line Out" on page 32.



Servicing / Remote Control



An integral USB port is used for firmware updates and remote control.

USB

USB 2.0 socket (Type B)

Connect here for firmware updates and remote control.



NOTE!

Remote Control will be available in a future release.

Channel Lock

The device settings can be locked against unwanted modification.



To toggle channel lock between ON and OFF push the channel encoders of source panel 1 and 4 (upper row, outer encoders) for a few seconds. Channel lock is displayed by all decimal points lighting up.

0.8	Channel lock OFF
0.8.	Channel lock ON

Factory Reset



Pushing all level encoders (lower row) for a few seconds recalls the company pre-set:

- Stereo (channel mode)
- Source Panel 1 to 4: ch. 01 / 03 / 05 / 07
- Mix volume +0
- Master volume phones / speakers 40
- Master volume AES / line +0

CHAPTER 5: Troubleshooting and Maintenance

Troubleshooting

To identify a possible defect with the device please consult the following table. If the fault cannot be resolved using these instructions, please contact your local DirectOut representative or visit support.directout.eu.

Issue	Possible reason	Solution
Device doesn't work.	Power supply is broken.	Check that the power supply switch is on, that the device is connected to the power supply and that the socket is working. Defective fuses must be exchanged by qualified service personal only.
Optical port does not work.	Optic is dirty.	Use an air supply to carefully remove any dust. Never use objects for cleaning.
No signal at the output port.	Connections (input / output) are mixed up.	Check the connections and change the cables if necessary. Check the routing matrix.
No signal at the output port.	Signal cable defective.	Exchange the signal cable.
MADI signal at the input is not stable.	Signal source is defective or bad signal condition (Jitter > 1 ns)- e.g. due to exceeded length or bad screening attenuation of signal cable.	Change the source or use appropriate cables.
Clicks in the audio signal.	Input source is not in sync with clock master of the box.	Check the status of input LED and check clock setting of the connected device.

Maintenance

To clean the device, use a soft, dry cloth. To protect the surface, avoid using cleaning agents.

NOTE!

The device should be disconnected from the power supply during the cleaning process.



CHAPTER 6: Technical Data

Dimensions

- Width 19" (483 mm)
- Height 1 RU (44.5 mm)
- Depth 7.8" (200 mm)
- Weight about 2 kg

Power Consumption

- 10 W (typical)

Power Supply

- 84 V- 264 V AC / 47 Hz- 63 Hz / Safety class 1

Fuses

- Fuse 250 V- 2 A (slow-blow) – 2 fuses per power supply

Environmental Conditions

- Operating temperature +5°C up to +45°C
- Relative humidity: 10%- 80%, non condensing

MADI Port SC optical

- 1 x SC socket FDDI (input / output)
- ISO/IEC 9314-3
- Wave length 1310 nm
- Multi-Mode 62.5/125 or 50/125

MADI Port BNC coaxial

- 2 x BNC socket (input / output)
- Impedance: 75 Ω
- 0.3 V up to 0.6 V (peak to peak)
- power fail through technology

MADI Port SFP

- 1 x SFP (empty cage without module)

Sample Rate

- 30- 50 kHz @1 FS
- 60- 100 kHz @2 FS

MADI Format (I/O)

- 48k Frame, 96k Frame
- 56 channel, 64 channel

AES3 I/O

- 1 x DSUB-9 (adaptor to XLR not included in delivery)

Line Output

- 1 x DSUB-9 (adaptor to XLR not included in delivery)
- balanced output
- Level: +24 dBu
- SNR: -114.5 dB / -117.3 dBA
- THD+N: -105.5 dB
- THD: -108 dB

Phones

- 1 x TRS jack 6.3 mm (stereo)
- Level: +18 dBu
- SNR: -114.2 dB / -117.1 dBA
- THD+N: -103 dB
- THD: -106 dB

Speakers

- Class-D power amplifier
- 2 speakers 2 W / 4 W (rated / max.)
- mean SPL 81 dB (1 W / 1 m)

USB

- 1 x USB socket (Type B)
- for firmware updates and remote control

Appendix A: Wiring AES I/O, Line Out DSUB-9 (female)

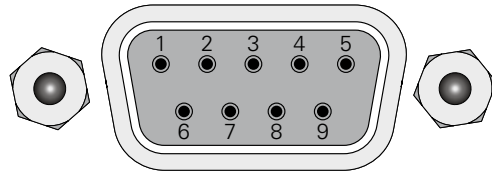

Pin	Signal
1	AES RX +
2	AES TX+
3	GND
4	Line Out L-
5	Line Out R-
6	AES RX-
7	AES TX-
8	Line Out L+
9	Line Out R+



NOTE!

The pinout does not comply with the adaptor delivered with MA2CHBOX.XT.

Index

Symbols

96 kHz..... 19

A

Accessory 12

C

Channel Lock 27

Clocking 19

Conditions of Warranty see Warranty

Conformity & Certificates

CE 11

RoHS 11

WEEE 11

Contact 11

Contents 12

Conventions..... 5

D

Defective Parts/Modules 8

Dimensions..... 30

DSUB-9

Adaptor 15

E

Environmental Conditions..... 14, 30

F

Factory Reset 27

Feature Summary 6

Firmware 16

First Aid 9

Fuses 30

I

Input Selection..... 19

Intended Operation..... 10

L

Level range

input 21

output 23

Link 20

Lock see Channel Lock

M

Master volume 22

Mix level 22

Muting 23

P

PFT see Power Fail Through

Power Fail Through 25

R

Remote Control 26

Reset see Factory Reset

S

SFP Modules 13

Support 29

T

Troubleshooting 29

U

Updates 10

W

Warranty 10

WEEE See Conformity & Certificates: WEEE

DirectOut GmbH

Leipziger Strasse 32
09648 Mittweida
Germany

T: +49-3727-5665-100
F: +49-3727-5665-101
www.directout.eu