

ASSEMBLING A-MODULES*

PRODIGY.MC (rear side)

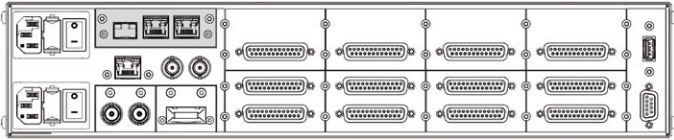

PRODIGY.MP (rear side)

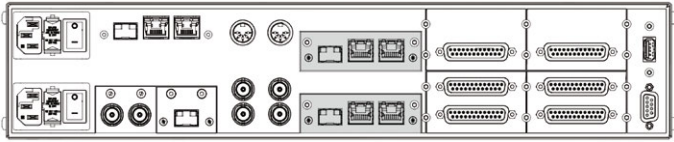

PRODIGY.MX (rear side)

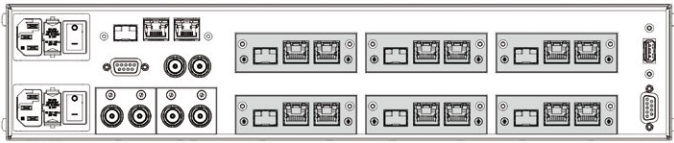

MAVEN.A (rear side)



* **A-Modules:** Audio Network, Multi-port MADI, USB
B-Modules: Single-port MADI
C-Modules: Converter AD/DA, Mic, AES3

The illustrations are exemplary and may differ from the existing hardware.

 possible slots

WARNING:

The device must be disconnected from the power supply before opening the housing. The modules may be changed only when the device is fully isolated.

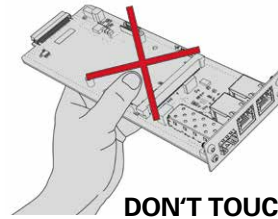
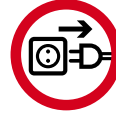

DON'T TOUCH SURFACE!

Place the housing on a firm and horizontal surface.

You need

Torx



T10

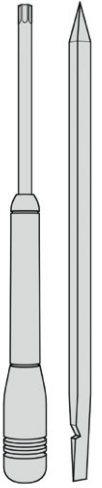

1  Remove Screws 2x

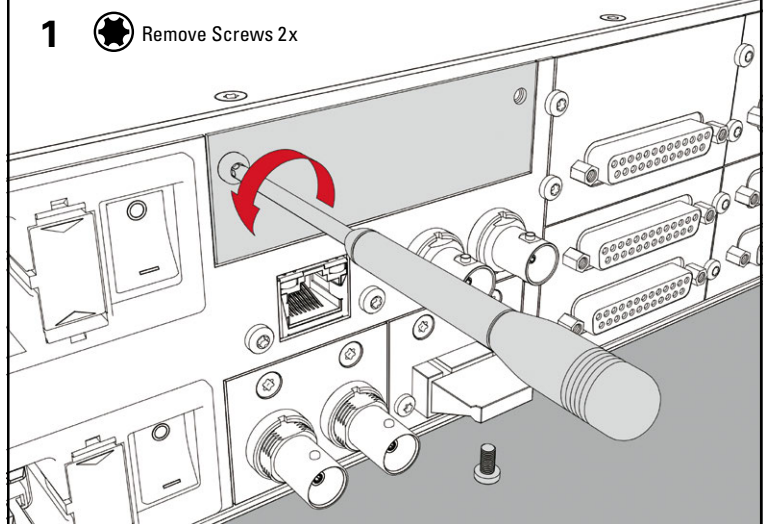

2 Remove Cover Plate

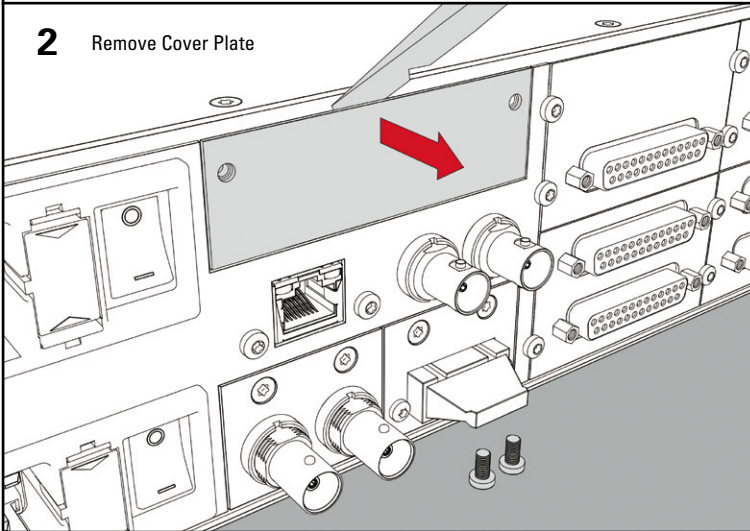

3 Insert A-Module

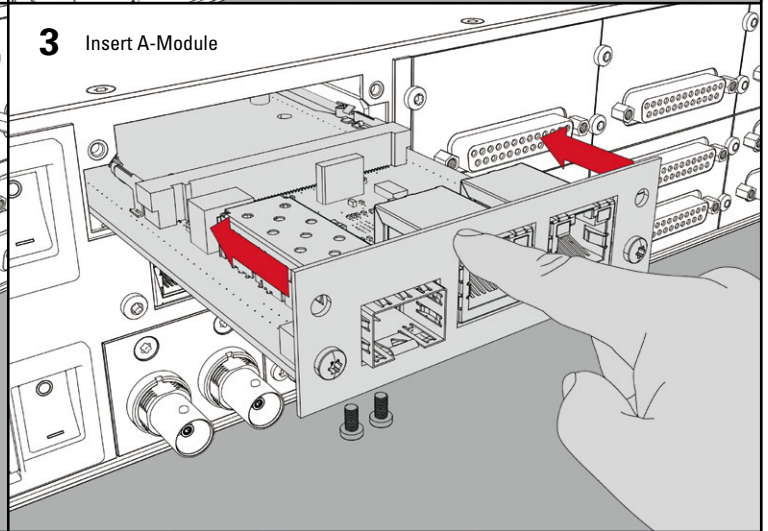

4  Fix Screws 2x

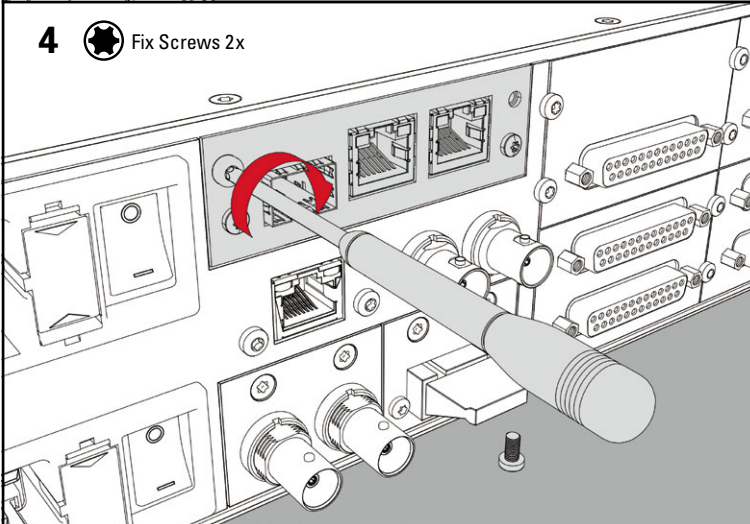

5 Ready!

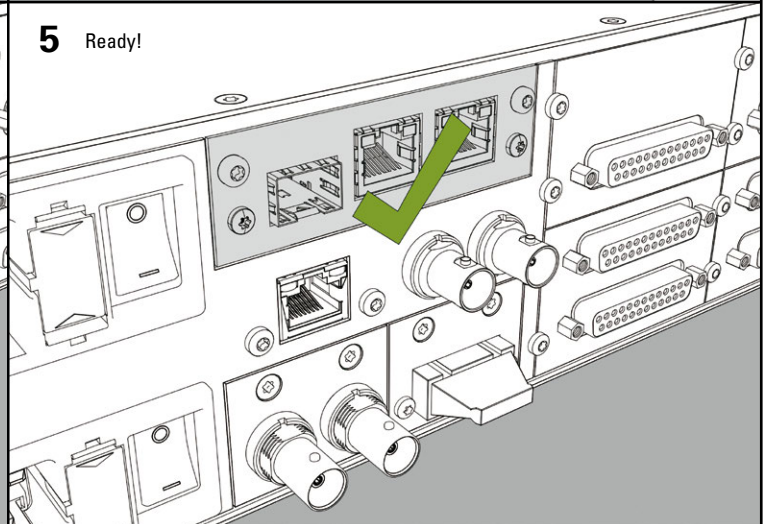

ASSEMBLING B-MODULES*

PRODIGY.MC (rear side)

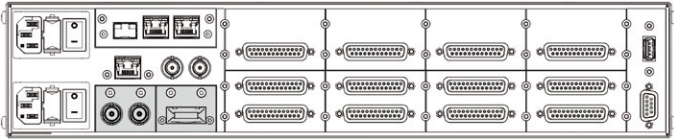

PRODIGY.MP (rear side)

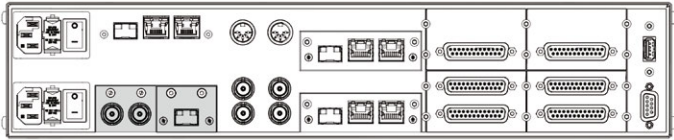

PRODIGY.MX (rear side)

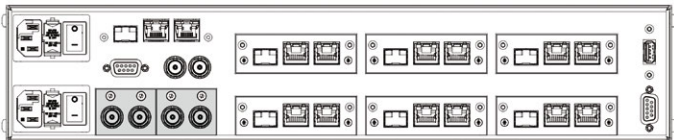

* **A-Modules:** Audio Network, Multi-port MADI, USB
B-Modules: Single-port MADI
C-Modules: Converter AD/DA, Mic, AES3

The illustrations are exemplary and may differ from the existing hardware.

 possible slots

WARNING:

The device must be disconnected from the power supply before opening the housing. The modules may be changed only when the device is fully isolated.

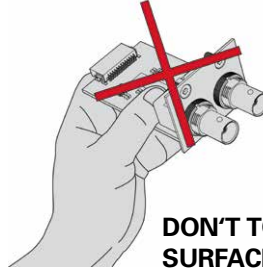
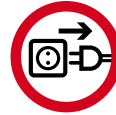

DON'T TOUCH SURFACE!

Place the housing on a firm and horizontal surface.

You need

Torx



T10

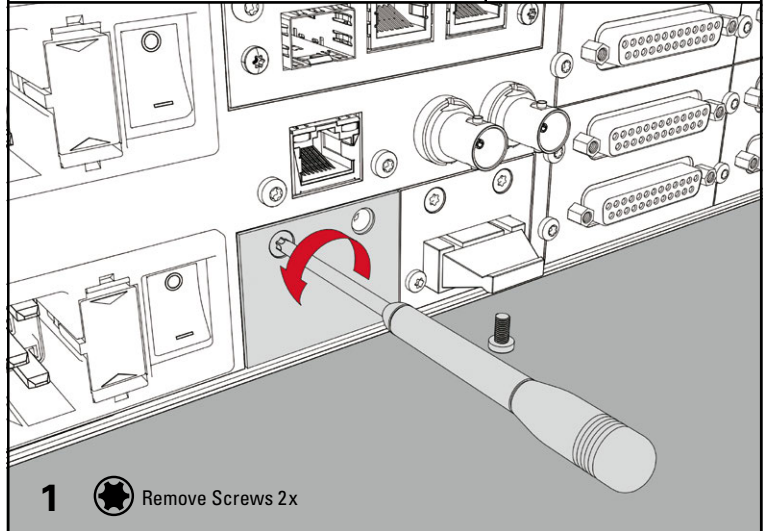
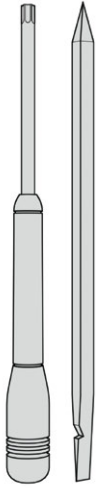

1  Remove Screws 2x

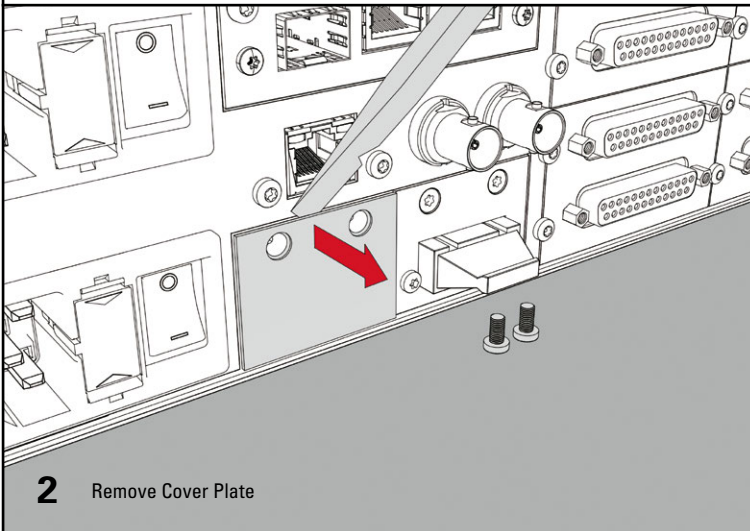

2 Remove Cover Plate

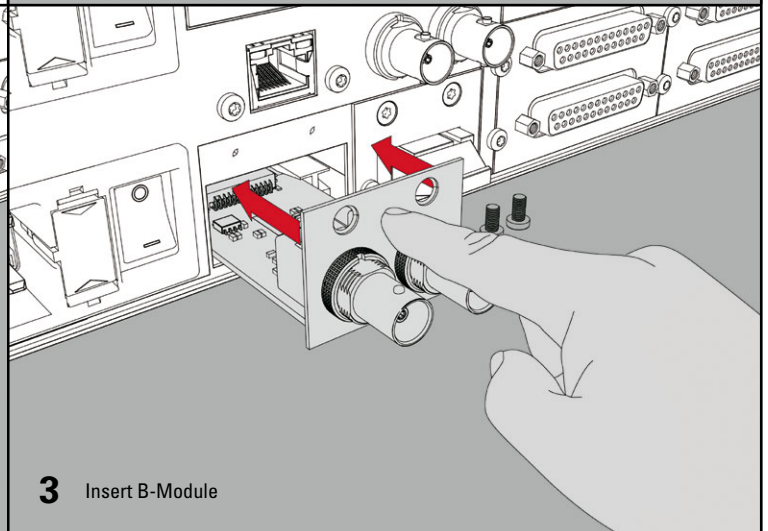

3 Insert B-Module

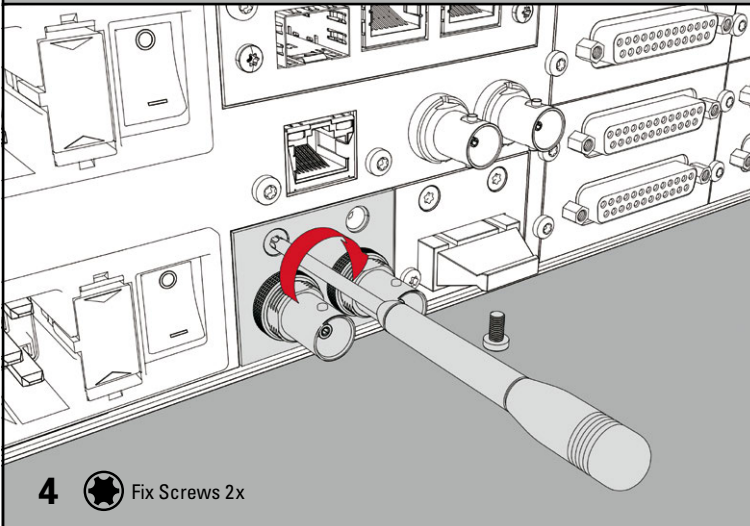

4  Fix Screws 2x

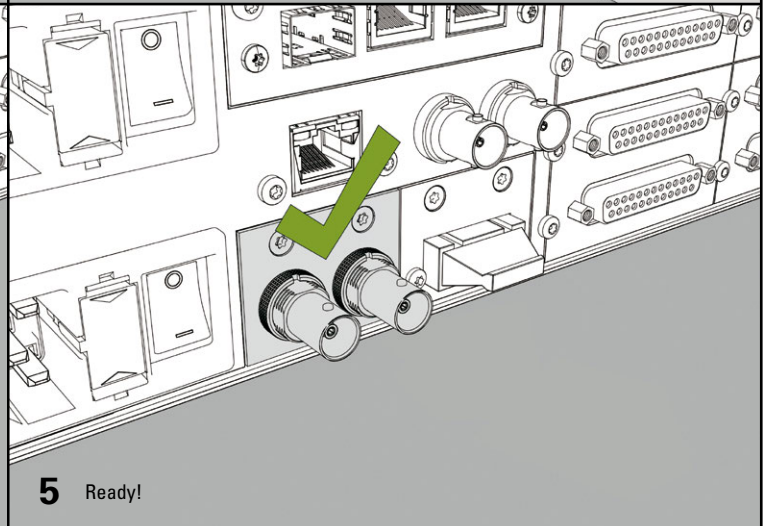

5 Ready!

ASSEMBLING C-MODULES*

PRODIGY.MC (rear side)

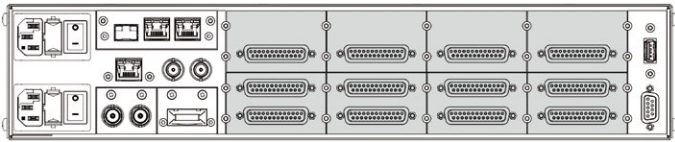

PRODIGY.MP (rear side)

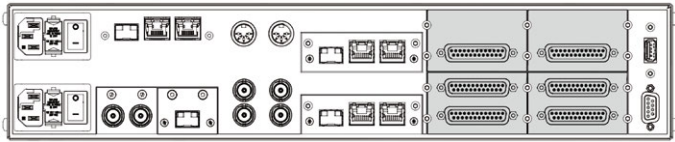

MAVEN.A (rear side)

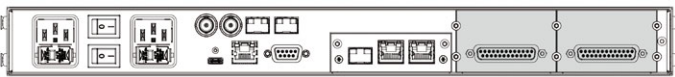

* **A-Modules:** Audio Network, Multi-port MADI, USB
B-Modules: Single-port MADI
C-Modules: Converter AD/DA, Mic, AES3

The illustrations are exemplary and may differ from the existing hardware.

 possible slots

WARNING:

The device must be disconnected from the power supply before opening the housing. The modules may be changed only when the device is fully isolated.

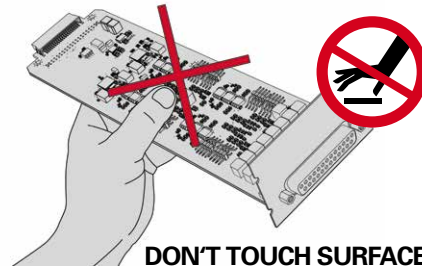
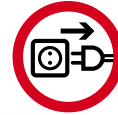

DON'T TOUCH SURFACE!

Place the housing on a firm and horizontal surface.

You need

Torx



T10

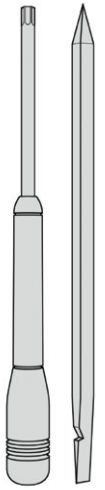

1  Remove Screws 4x

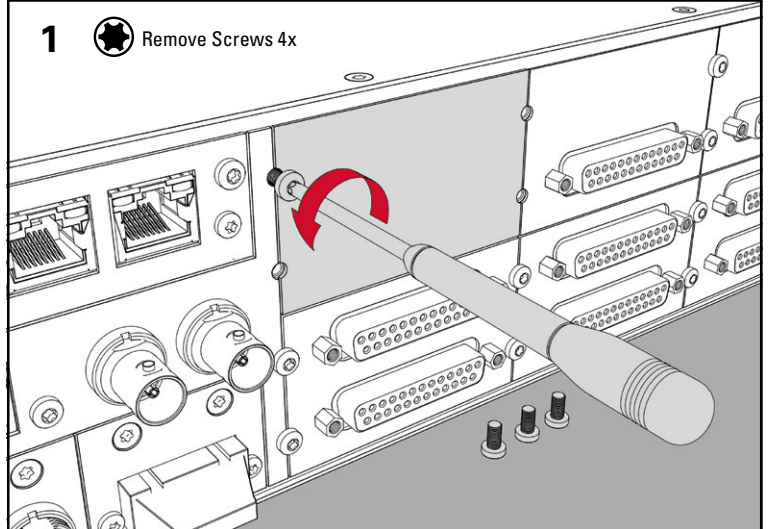

2 Remove Cover Plate

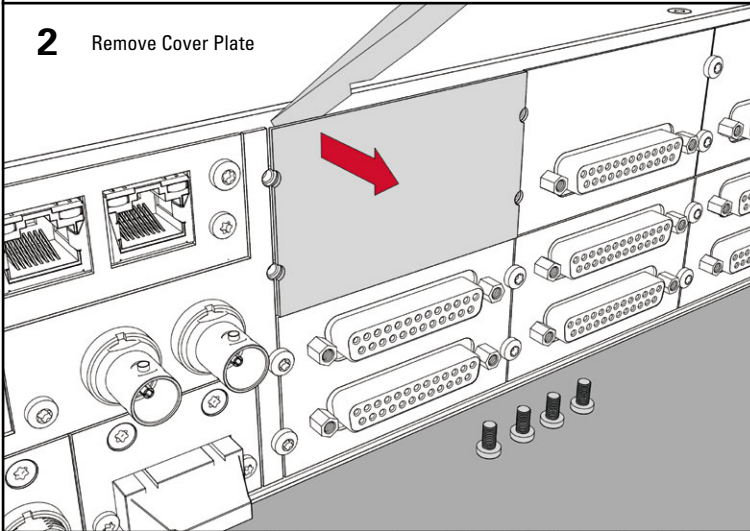

3 Insert C-Module

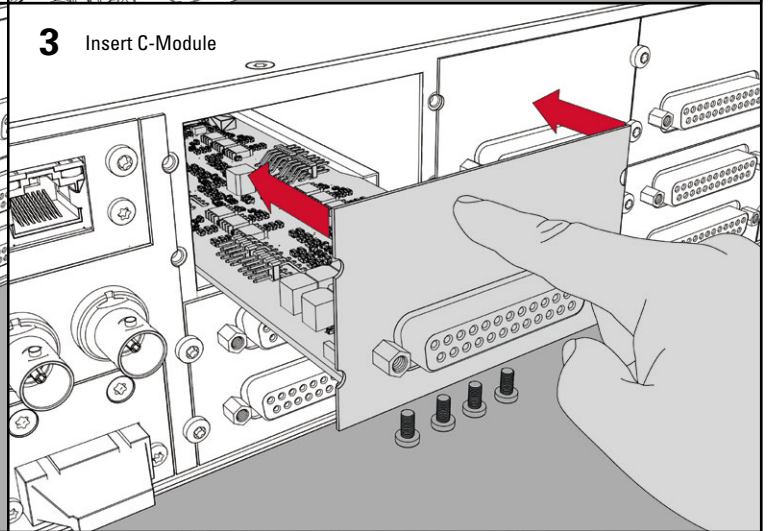

4  Fix Screws 4x

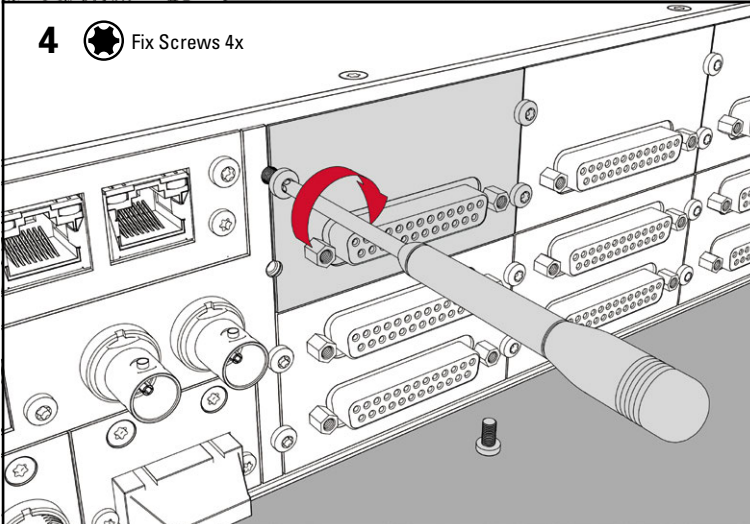

5 Ready!

