

# EXBOX.RAV

User's Manual



### Copyright

All rights reserved. Permission to reprint or electronically reproduce any document or graphic in whole or in part for any reason is expressly prohibited, unless prior written consent is obtained from the DirectOut GmbH.

All trademarks and registered trademarks belong to their respective owners. It cannot be guaranteed that all product names, products, trademarks, requisitions, regulations, guidelines, specifications and norms are free from trade mark rights of third parties.

All entries in this document have been thoroughly checked; however no guarantee for correctness can be given.

DirectOut GmbH cannot be held responsible for any misleading or incorrect information provided throughout this manual.

DirectOut GmbH reserves the right to change specifications at any time without notice.

DirectOut Technologies® is a registered trademark of the DirectOut GmbH.

© DirectOut GmbH, 2025

---

## Table of contents

<b>About This Manual</b>	<b>5</b>
How to Use This Manual.....	5
Conventions .....	5
<b>CHAPTER 1: Overview</b>	<b>6</b>
Introduction .....	6
Feature Summary.....	7
Applications.....	7
How it works.....	8
<b>CHAPTER 2: Legal issues &amp; facts</b>	<b>10</b>
Before Installing This Device.....	10
Defective Parts/Modules .....	10
First Aid (in case of electric shock).....	11
Updates.....	12
Conditions of Warranty .....	12
Intended Operation .....	12
Conformity & Certificates .....	13
Contact.....	13
Contents .....	14
Accessory.....	15
<b>CHAPTER 3: Installation</b>	<b>17</b>
Installing the Device .....	17
<b>CHAPTER 4: Operation</b>	<b>21</b>
Introduction .....	21
Global Control.....	22
Input / Output - MADI .....	23
Input / Output - Network.....	24
Input State / Clocking .....	25
Sample Rate .....	28
State.....	29

<b>CHAPTER 5: Remote Control</b>	<b>30</b>
Introduction .....	30
Browser Control .....	32
Status - Overview.....	33
Status - Sync .....	34
Status - Network .....	39
Status - Device .....	42
Status - Input Streams.....	46
Status - Output Streams.....	58
Matrix .....	62
EARS™ .....	64
Advanced - Overview .....	72
Advanced - PTP Settings.....	73
Advanced - PTP Unicast.....	75
Advanced - PTP Profile Customized Settings.....	76
Advanced - Current PTP Master.....	78
Advanced - PTP Clock Setting.....	78
Advanced - PTP Statistic .....	79
Advanced - Network Advanced Settings .....	80
Advanced - PTP Jitter.....	81
NMOS - Overview.....	82
NMOS port - NIC1 & NIC2.....	82
Search mode NMOS registry.....	83
NMOS - Additional Settings .....	84
Logging .....	86
Statistic.....	88
Switch .....	89
Tools.....	90
<b>CHAPTER 6: Troubleshooting and Maintenance</b>	<b>94</b>
Troubleshooting.....	94
Maintenance.....	95
<b>CHAPTER 7: Technical Data</b>	<b>96</b>
<b>Appendix A - Wiring Sketches</b>	<b>98</b>
Hirose HR10 (DC PSU).....	98
<b>Appendix B - Working with BLDS™</b>	<b>99</b>
Introduction .....	99
BLDS™ Generator.....	99
<b>Appendix C - Working with ch 57 mode</b>	<b>101</b>
<b>Appendix D - Firmware Update</b>	<b>102</b>
<b>Index</b>	<b>104</b>



## About This Manual

### How to Use This Manual

This manual guides you through the installation and operation of the device. Use the Table of Contents at the beginning of the manual or Index Directory at the end of the document to locate help on a particular topic. You can access more information and latest news by visiting on the DirectOut website at [www.directout.eu](http://www.directout.eu).

### Conventions

The following symbols are used to draw your attention to:

#### **TIPS**

indicate useful hints and shortcuts.



#### **NOTES**

are used for important points of clarification or cross references.



#### **WARNINGS!**

alert you when an action should always be observed.



## CHAPTER 1: Overview

### Introduction

EXBOX.RAV is an Audio-over-IP to MADi converter based on the audio networking technology RAVENNA.

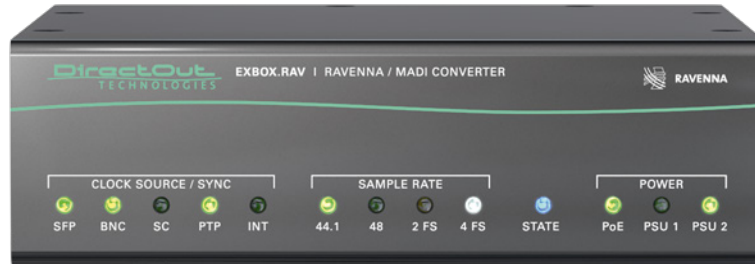

Equipped with three MADi ports and four network ports it offers straight-forward conversion of 64 audio channels between MADi and RAVENNA.



Two independent NICs can be connected to four network ports of the built-in switch, supporting redundant audio streaming as per ST 2022-7.

## Feature Summary

MADI Ports	1 x SC multi-mode connectors * 1 x SFP (empty cage without module) 1 x coaxial BNC connectors
Network	3 x RJ45 Socket (1 Gbit/s), 1 x RJ45 (1 Gbit/s, PoE)
Number of streams	32
Number of channels	64 @ 1 FS, 32 @ 2 FS, 16 @ 4 FS
Network Standards	RAVENNA, AES67, ST 2110-30 / -31
Modes	Switched or Redundancy as per ST 2022-7
Clock Sources	PTP, MADI, WCK, INT
Remote	Browser GUI, globcon control, NMOS IS-04 / IS-05
MADI Formats	56/64 channel, 48k/96k Frame, S/MUX 2/4
Sample Rates	44.1, 48, 88.2, 96, 176.4, 192 kHz +/-12.5%
Signal Routing	Channel based routing matrix
Signal Processing	FastSRC™ at RAVENNA I/O
Signal Redundancy	Enhanced Automatic Redundancy Switching (EARST™)
Power Supply	external, 2 x Hirose connector (9-24 V) 1 x PoE (Power over Ethernet, IEEE 802.3af)

\* The SC I/O may be ordered as single-mode upon request.

## Applications

EXBOX.RAV can be used as an easy to use frontend for bidirectional signal exchange between RAVENNA and MADI environments.

Typical applications include:

- Integration of MADI in RAVENNA setups
- Signal Routing via NMOS  
in broadcast environments
- Signal switch for redundant playback setups

### How it works

Each MAD1 port and the RAVENNA input can be selected as source for any output. A FastSRC™ can be enabled for seamless exchange of audio signals with the RAVENNA network if the device is not clocked to the audio network.

The network audio is controlled via the browser based user interface or globcon or via an NMOS controller.

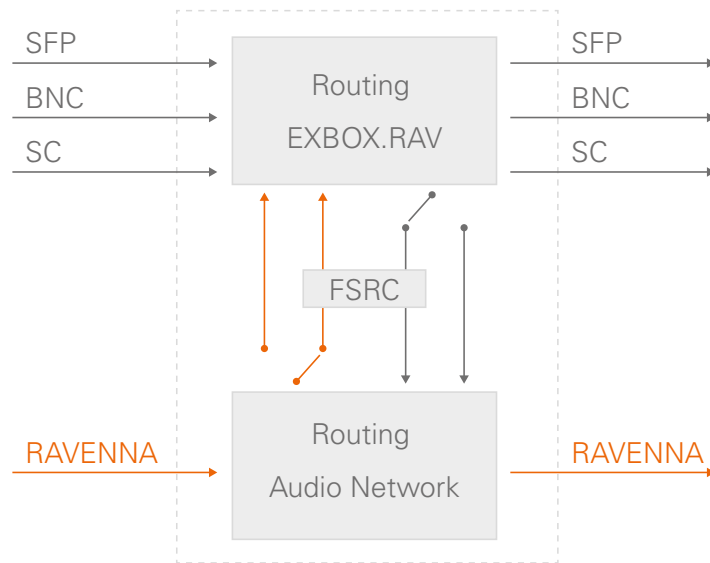

About FastSRC™ - see page 26.

This page is left blank intentionally.



## CHAPTER 2: Legal issues & facts

### Before Installing This Device



#### **WARNING!**

---

**Please read and observe all of the following notes before installing this product:**

- Check the hardware device for transport damage.
- Any devices showing signs of mechanical damage or damage from the spillage of liquids must not be connected to the mains supply, or disconnected from the mains immediately by pulling out the power lead.
- All devices must be grounded. The device is grounded through its IEC power connections.
- All devices must be connected to the mains using the three-cord power leads supplied with the system. Only supply electrical interfaces with the voltages and signals described in these instructions.
- Do not use the device at extreme temperatures. Proper operation can only be guaranteed between temperatures of 5° C and 45° C and a maximum relative humidity of 80 %, non-condensing.
- The cabinet of the device will heat up. Do not place the device close to heating sources (e.g. heaters). Observe the environmental conditions.

### Defective Parts/Modules



#### **WARNING!**

---

This device contains no user-serviceable parts. Therefore do not open the device. In the event of a hardware defect, please send the device to your DirectOut representative together with a detailed description of the fault.

We would like to remind you to please check carefully whether the failure is caused by erroneous configuration, operation or connection before sending parts for repair.

## First Aid (in case of electric shock)

### **WARNING!**

---



- Do not touch the person or his/her clothing before power is turned off, otherwise you risk sustaining an electric shock yourself.
- Separate the person as quickly as possible from the electric power source as follows:
  - Switch off the equipment.
  - Unplug or disconnect the mains cable.
- Move the person away from the power source by using dry insulating material (such as wood or plastic).
- If the person is unconscious:
  - Check their pulse and reanimate if their respiration is poor.
  - Lay the body down and turn it to one side. Call for a doctor immediately.
- Having sustained an electric shock, always consult a doctor.

### Updates

DirectOut products are continually in development, and therefore the information in this manual may be superseded by new releases. To access the latest documentation, please visit the DirectOut website:  
[www.directout.eu](http://www.directout.eu).

This guide refers to firmware version 1.7.9 and AoIP module version HW 0.36 / SW 1.20.

### Intended Operation

EXBOX.RAV is designed for conversion / routing between network audio and MADI signals. MADI refers to AES10, network audio refers to RAVENNA (including AES67 and SMPTE ST 2110-30 /-31).



---

### WARNING!

No compensation can be claimed for damages caused by operation of this unit other than for the intended use described above. Consecutive damages are also excluded explicitly. The general terms and conditions of business of DirectOut GmbH are applied.

### Conditions of Warranty

This unit has been designed and examined carefully by the manufacturer and complies with actual norms and directives.

Warranty is granted by DirectOut GmbH over the period of 36 months for all components that are essential for proper and intended operation of the device. The date of purchase is applied for this period.

Consumable parts (e.g. battery) are excluded from warranty claims.



---

### WARNING!

All claims of warranty will expire once the device has been opened or modified, or if instructions and warnings were ignored.

For warranty claims please contact the dealer where your device was acquired.

## Conformity & Certificates

### CE

This device complies with the basic requests of applicable EU guidelines. The appropriate procedure for approval has been carried out.

### RoHS

(Restriction of the use of certain Hazardous Substances)

This device was constructed fulfilling the directive on the restriction of the use of certain hazardous substances in electrical and electronic equipment 2011/65/EU and 2015/863.

### WEEE

(Directive on Waste Electrical and Electronic Equipment)

Due to the directive 2002/96/EC for waste disposal this device must be recycled.

For correct recycling please dispatch the device to:

DirectOut GmbH,  
Hainichener Str. 66a  
09648 Mittweida  
Germany

Only stamped parcels will be accepted!

WEEE-Reg.-No. DE 64879540

### Contact

DirectOut GmbH  
Hainichener Str. 66a, 09648 Mittweida, Germany  
Phone: +49 (0)3727 5650-00  
Mail: [sales@directout.eu](mailto:sales@directout.eu)  
[www.directout.eu](http://www.directout.eu)

## Contents

The contents of your EXBOX.RAV package include:

- 1 x EXBOX.RAV
- 1 x external power supply unit (9 - 24 V)
- 1 x Instruction Leaflet

## Remote Control

The device can be managed either via web control in a browser or via globcon remote control.

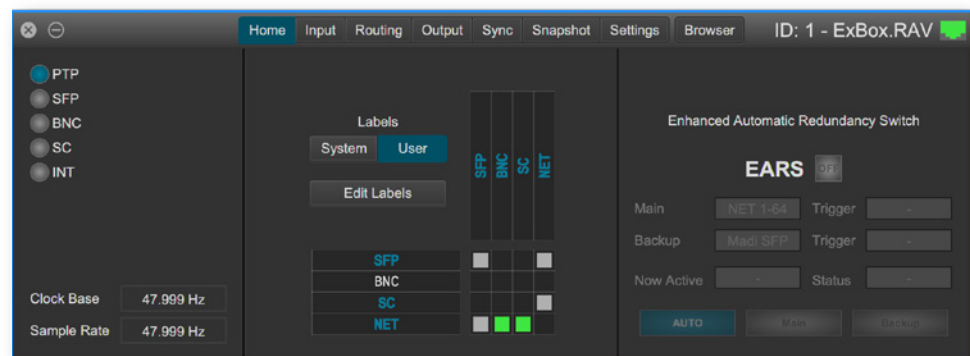

## globcon

globcon is a free, global control software platform for the management of professional audio equipment. Almost all products of the DirectOut product portfolio are supported by globcon.

Link: [www.globcon.pro](http://www.globcon.pro)



## Accessory

Two different optical SFP transceiver for MAD1 transmission are available from DirectOut GmbH:

- Multi-mode SFP transceiver with LC connectors (No: DOICT0129)
- Single-mode SFP transceiver with LC connectors (No: DOICT0130)

### Specification of the optical SFP transceivers:

SFP	Multimode	Singlemode
Wavelength TX nominal	1310 nm	1310 nm
Wavelength RX nominal	1310 nm	1310 nm
Distance	2 km	10 km
Powerbudget (dB)	> 11 dB	> 12 dB
Protocols	Fast Ethernet OC3/STM1	Gigabit Ethernet, Gigabit Fibre Channel
Bandwidth from	100 Mbit/s	1.050 Gbit/s
Bandwidth	155 Mbit/s	1.250 Gbit/s
Laser	FP	FP
Receiver Type	PIN	PIN
Connector	LC	LC
Wavelength TX min	1260 nm	1260 nm
Wavelength TX max	1360 nm	1360 nm
Wavelength RX min	1260 nm	1260 nm
Wavelength RX max	1620 nm	1600 nm
Transmit min	- 19.00 dBm	- 9.00 dBm
Transmit max	- 14.00 dBm	- 3.00 dBm
Receive min	- 30 dBm	- 21.00 dBm
Receive max (Receiver overload)	- 5.00 dBm	- 3.00 dBm
Temperature (min)	0° Celsius	0° Celsius
Temperature (max)	70° Celsius	70° Celsius
Type of DDM/DOM	internal	internal
Extinction Ratio	8.20 dB	9 dB

BOXMOUNT XL- for optimal rack mount of up to three devices in a 19" frame  
(No: DOAPA0886):



## CHAPTER 3: Installation

### Installing the Device

1. Open the packaging and check that the contents have been delivered complete and undamaged.
2. Place the device on a non-slip horizontal surface. The delivered pads may be affixed to the bottom of the cabinet. Ensure a clean and dry surface before affixing the pads.

### WARNING!



The synthetics of the delivered pads might cause stains on damageable surfaces. To avoid staining of furniture surfaces it is recommended to place a protective plate under the device.

### WARNING!



Avoid damage from condensation by waiting for the device to adapt to the environmental temperature. Proper operation can only be guaranteed between temperatures of 5° C and 45° C and a maximum relative humidity of 80%, non-condensing.

Ensure that the unit has sufficient air circulation for cooling.

3. Remove the protective cap from the optical MADI port(s) before use.



### NOTE



Retain the protective cap if the optical port is unused. This will protect against soiling which can lead to malfunction.

4. Connect signal cable(s) for the MADI signals.



5. Plug in the network cable to the ethernet port(s) to connect the device with your computer.

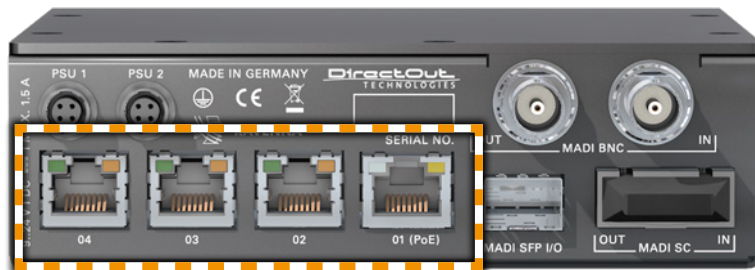

**Default network configuration:**

- Use Port 1 for access via 192.168.0.1
- Use Port 2 for access via DHCP



**NOTE**

Use appropriate network cables (CAT5E or better).

6. Using the power cord of the external power supply provided, connect the device to a matching power supply and connect the output of the power supply to the Hirose connectors at the rear panel.



This device may operate with only one power supply. To provide power supply redundancy, it is recommended to connect both PSU 1 and PSU 2 to independent power supplies with separate fuses.

## NOTE



The shipment includes one external power supply unit. Additional power supply units are available from your local DirectOut representative.

## WARNING!



The external power supply must be connected to the mains using the three-cord power leads supplied with the device. Only supply the voltages and signals indicated (9 - 24 V DC) to the device.

## WARNING!



The connected power supply must provide a current limiting to a maximum of 2.5 A.



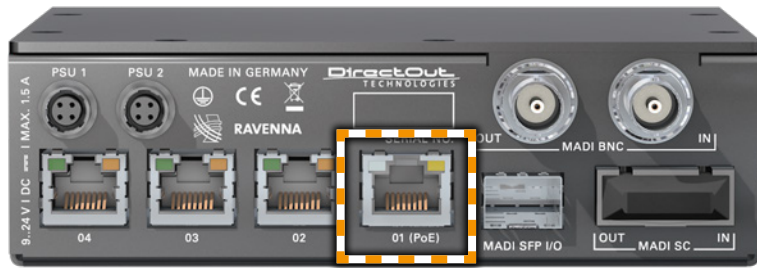

### Power over Ethernet

The device can also be operated via a power over ethernet connection. Connect the port labelled '01 (PoE)' to an appropriate PoE switch (PoE Class 0 / 0.4 - 13W, IEEE 802.3af).



### WARNING!

Never connect a PoE link to a network interface that is not marked explicitly for PoE operation. The voltage supplied there may damage the interface.



### TIP

Keep any packaging in order to protect the device should it need to be dispatched for service.

## CHAPTER 4: Operation

### Introduction

This chapter describes the basic operation of the device.

Note that throughout this manual, the abbreviation FS refers to sample rate or sample frequency. So, when dealing with scaling factors, the following sample rates can be written as:

- 44.1 kHz or 48 kHz = 1 FS
- 88.2 kHz or 96 kHz = 2 FS
- 176.4 kHz or 192 kHz = 4 FS

## Global Control



PSU 1	<b>Hirose socket</b> Connect the power supply here (9- 24 V DC).
PSU 2	<b>Hirose socket</b> Connect the power supply here (9- 24 V DC).
01 (PoE)	<b>RJ45 socket</b> Connect PoE link here. PoE Class 0 / 0.4 - 13 W



### NOTE

The device does not provide a power switch. Connecting a working power supply to the device will power up the device immediately.



### WARNING!

Never connect a PoE link to a network interface that is not marked explicitly for PoE operation. The voltage supplied there may damage the interface.



POWER	<b>LED green - indicates state of power supply</b>
PSU 1	○ (OFF) = power supply not working
PSU 2	● (ON) = power supply working
PoE	

## Input / Output - MADI

Three different MADI ports enable flexible connectivity in various scenarios. Due to the device's routing capabilities format conversion between different MADI formats is possible.

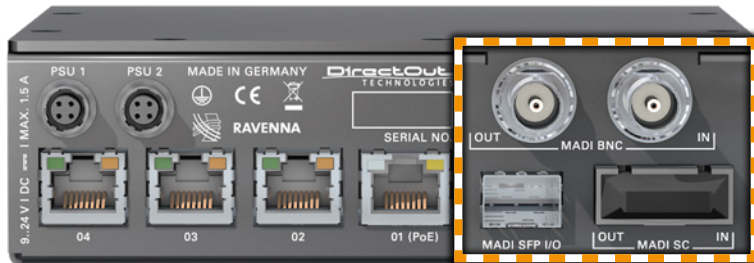

MADI BNC OUT	<b>BNC socket</b> MADI output - connect here for MADI output signal.
MADI BNC IN	<b>BNC socket*</b> MADI or WCK input - connect MADI or word clock input signal here.
MADI SC OUT	<b>SC socket</b> MADI output - connect here for MADI output signal.
MADI SC IN	<b>SC socket</b> MADI input - connect MADI input signal here.
MADI SFP I/O	<b>SFP socket</b> Insert SFP module here and connect MADI input/output.



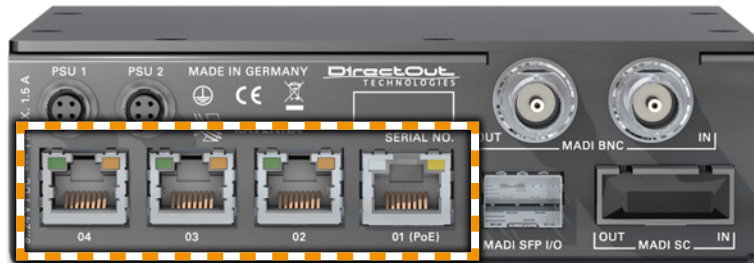

\* The BNC input may be operated as word clock input (AES11) - see p 27.

### Input / Output - Network

Four network ports are available for transmission of audio signals and remote control. Two independent network interface controllers (NICs) can connect with each of the four network ports of the built-in switch.



More details about the switch configuration - see page 89.

01 (PoE)	<b>RJ45 socket (1 Gbit/s)</b> Network interface - connect here for network transmission. This port accepts a PoE source for power supply - see page 22.
02	<b>RJ45 socket (1 Gbit/s)</b> Network interface - connect here for network transmission.
03	<b>RJ45 socket (1 Gbit/s)</b> Network interface - connect here for network transmission.
04	<b>RJ45 socket (1 Gbit/s)</b> Network interface - connect here for network transmission.
LED left (Port 1 to 4)	<b>LED orange - indicates the link state of the network connection*.</b>  (ON) = device link active  (OFF) = device link not active
LED right (Port 1 to 4)	<b>LED green - indicates the activity state of the network connection.</b>  (ON) = data sent or received  (OFF) = no data transmission

\* Some possible reasons that lead to an inactive link:

- device switched off
- connected device switched off
- cabling issue

## Input State / Clocking

Five LEDs inform about the state of each signal input and the selected clock source of the device.

The device offers several options for clocking:

- PTP (Precision Time Protocol) - IEEE 1588-2002 / PTPv2
- MADI input
- Word Clock (@ MADI BNC input)\*
- internal clock generator

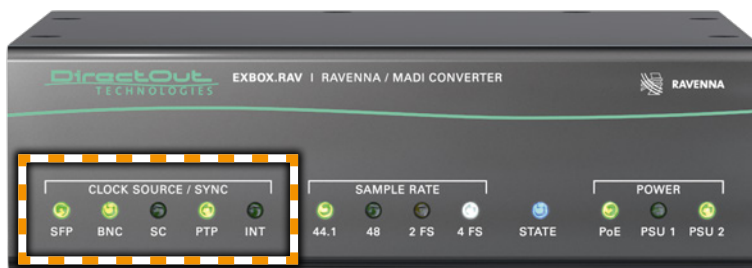

CLOCK SOURCE / SYNC	<b>LED - indicates selected clock source and the lock / sync state of MADI input, PTP-clock or the internal clock generator.</b>
SFP	○ (OFF) = no signal lock
BNC*	◐ (50 % green) = signal lock, in sync
SC	◑ (100 % green) = signal lock, in sync, selected clock source
PTP	⦿ (blinking red) = signal lock, not in sync with selected clock source
INT	◑ (blinking green) = input selected as clock source and no signal lock.

\* See „Clocking to word clock“ on page 27.

The PTP configuration and clock source of the device is adjusted via remote control. EXBOX.RAV can act as a PTP slave or Grandmaster (preferred master).

### Sample Rate Conversion

A switchable sample rate converter is available for the audio network I/O. This is helpful if the device can't be clocked to the audio network (or act as grandmaster). The three MAD I ports must belong to the identical clock domain.

The FastSRC™ is a low latency sample rate converter and ensures seamless exchange between MAD I and RAVENNA I/O when both sources are not synchronised. It is either switchable in the EXBOX Remote or in globcon.

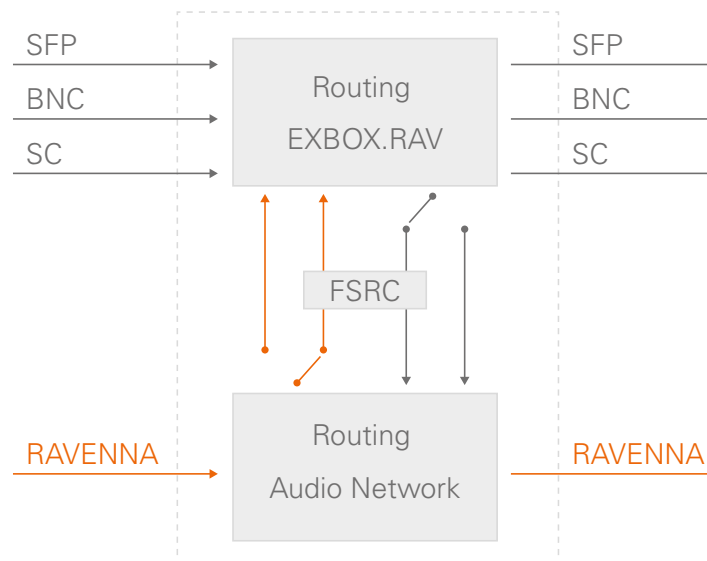

#### NOTE

When the device is clocked via PTP, it is neither necessary nor recommended to activate the FSRC.



#### NOTE

With the FastSRC™ activated at the RAVENNA I/O the trigger signal detection of EARST™ is limited to Pilot tone - see "EARST™- Triggering" on page 68.

### About FastSRC™

DirectOut's FastSRC™ is a low latency sample rate converter for when two digital interfaces of a device must work in different clock domains.

FastSRC™ combines good sound quality with very low latency of less than 0.15 msec and is invaluable in live sound applications and a "life-saver" in critical situations.

High-end sample rate conversion requires noticeable processing power, so for the very best audio quality we recommend DirectOut's dedicated SRC products such as the SRC version of the audio network modules or the multi-port MAD I modules.

**Clocking to word clock**

The BNC MADI input also accepts a word clock signal according to AES11. The operating mode of the BNC input is selected in the Remote control

- see p 38.

CLOCK SOURCE / SYNC BNC	<p><b>LED - indicates selected clock source and the lock / sync state of MADI BNC / WCK input.</b></p> <ul style="list-style-type: none"> <li>○ (OFF) = no signal lock</li> <li>● (50 % green) = signal lock, in sync</li> <li>● (100 % green) = signal lock (MADI), in sync, selected clock source</li> <li>● (100 % purple) = signal lock (WCK), in sync, selected clock source</li> <li>● (blinking red) = signal lock, not in sync with selected clock source</li> <li>● (blinking green) = input selected as clock source (MADI) and no signal lock.</li> <li>● (blinking purple) = input selected as clock source (WCK) and no signal lock.</li> </ul>
-------------------------	--

Independent from the operating mode of the MADI BNC input the MADI BNC output does output a MADI signal.

**TIP**



With the FastSRC™ activated you may clock the device to word clock and connect seamlessly to the RAVENNA network.

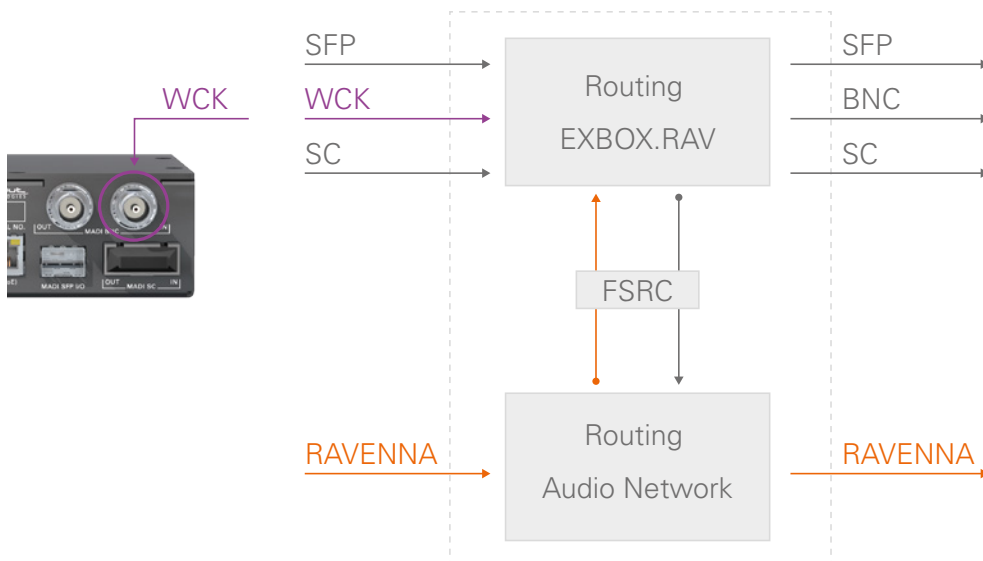



### Sample Rate

The base rate (44.1 kHz, 48 kHz) and the scaling factor (1 FS, 2 FS, 4 FS) is displayed by four LEDs at the front panel.

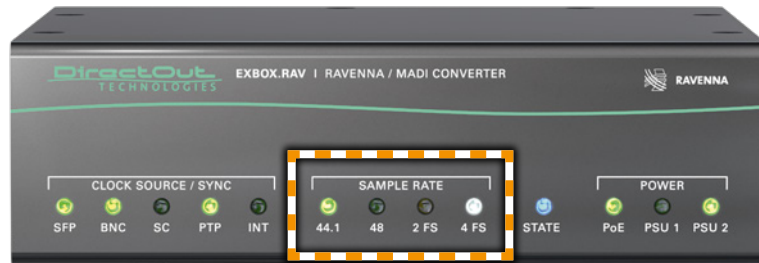

### NOTE

At higher sample rates the number of audio channels is reduced depending on the integer of the scaling factor:

- 64 channels at 1 FS
- 32 channels at 2 FS
- 16 channels at 4 FS

SAMPLE RATE 44.1k	<p><b>LED green - indicates the base rate of the audio engine.</b></p> <p><input type="radio"/> (OFF) = base rate is different from 44.1 kHz  <input checked="" type="radio"/> (ON) = base rate of 44.1 kHz (or multiple of) is used</p>
SAMPLE RATE 48k	<p><b>LED green - indicates the base rate of the audio engine.</b></p> <p><input type="radio"/> (OFF) = base rate is different from 48 kHz  <input checked="" type="radio"/> (ON) = base rate of 48 kHz (or multiple of) is used</p>
SAMPLE RATE 2 FS	<p><b>LED yellow - indicates the scaling factor of the base rate.</b></p> <p><input type="radio"/> (OFF) = scaling factor is 1 FS  <input checked="" type="radio"/> (ON) = scaling factor is 2 FS  <input type="radio"/> (blinking) = scaling factor does not match the sample rate of the RAV2 module.</p>
SAMPLE RATE 4 FS	<p><b>LED white - indicates the scaling factor of the base rate.</b></p> <p><input type="radio"/> (OFF) = scaling factor is 1 FS  <input checked="" type="radio"/> (ON) = scaling factor is 4 FS</p>

## State

The status of the RAV2 module is monitored by a LED at the front.

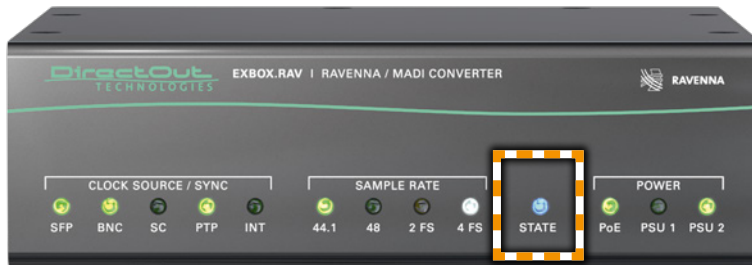

### STATE

**LED blue - indicates the state of the RAV2 module.**

- (OFF) = module not available
- (ON) = module is working
- (blinking) = module in failsafe mode\*

\* The RAV2 module starts into failsafe mode if its firmware is corrupted. This may happen in very rare cases only. Should you encounter this state, please contact support for further information.

## CHAPTER 5: Remote Control

### Introduction

EXBOX.RAV can be controlled via a browser based interface and globcon (partially). For control via 3rd party devices NMOS IS-04 (stream and device discovery) and IS-05 (connection management) are supported.

### Browser interface

The screenshot displays the web interface for EXBOX.RAV-200b86. At the top, there are navigation tabs: STATUS (selected), MATRIX, EARS, ADVANCED, NMOS, LOGGING, ABOUT, STATISTIC, SWITCH, and TOOLS. The main content area is divided into three columns:

- SYNC:** Contains settings for MADI & NET Sample Rate (PTP @ 47999Hz), NET FastSRC (Off), NET Clock Reference (PTP), NET Sample Rate (48 kHz), MADI Clock Reference (PTP), MADI Factor (FS) (1), PTP state (slave), PTP jitter (8.58 us), PTP offset (-0.35 us), RTP state (ok), and Audio engine (RX and TX states).
- NETWORK:** Shows device information including Name (EXBOX.RAV-200b86), MAC address (A0-BB-3E-20-0B-86), IP address (192.168.72.4), and details for NIC 1 and NIC 2.
- DEVICE:** Displays hardware status such as Temp CPU (75 °C), Temp switch (52 °C), and PSU status (PSU 1 and PSU 2).

Below these panels are two tables for stream management:

INPUT STREAMS				OUTPUT STREAMS			
01	Studio A	8 ch	17	01	Feed A	16 Ch	17
02	Studio B	8 ch	18	02	Feed B	6 Ch	18
03	Studio C	8 ch	19	03	Feed C	2 Ch	19
04	Studio D	8 ch	20	04	Feed D	24 Ch	20
05	-	8 ch	21	05	EXBOX.RAV-200b86_stream_5	8 Ch	21
06	-	8 ch	22	06	EXBOX.RAV-200b86_stream_6	8 Ch	22
07	-	8 ch	23	07	EXBOX.RAV-200b86_stream_7	8 Ch	23
08	-	8 ch	24	08	EXBOX.RAV-200b86_stream_8	8 Ch	24
09	-	8 ch	25	09	EXBOX.RAV-200b86_stream_9	8 Ch	25
10	-	8 ch	26	10	EXBOX.RAV-200b86_stream_...	8 Ch	26
11	-	8 ch	27	11	EXBOX.RAV-200b86_stream_...	8 Ch	27
12	-	8 ch	28	12	EXBOX.RAV-200b86_stream_...	8 Ch	28
13	-	8 ch	29	13	EXBOX.RAV-200b86_stream_...	8 Ch	29
14	-	8 ch	30	14	EXBOX.RAV-200b86_stream_...	8 Ch	30
15	-	8 ch	31	15	EXBOX.RAV-200b86_stream_...	8 Ch	31
16	-	8 ch	32	16	EXBOX.RAV-200b86_stream_...	8 Ch	32

The size of the window and the zoom level can be varied. The page is organized in tabs, pulldown menus or hyperlinks offer access to the values of a parameter. Some values use an input field (e.g. IP address).

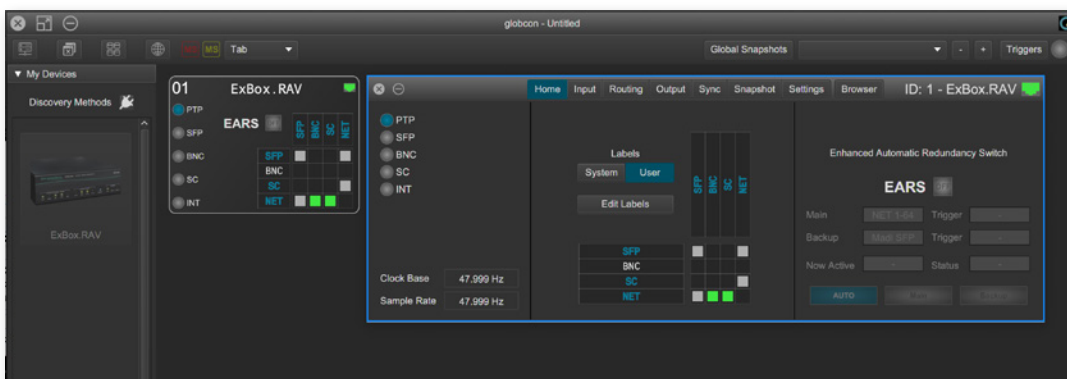
**globcon**

The device is found by globcon via Discovery Method: Ethernet

The browser interface can also be opened in globcon to:

- manage the stream setup
- modify network settings
- modify switch configuration
- load / save a device preset
- update the firmware of the device

### Browser Control

To access the control page:

- connect the network with one port
- enter http://<IP Address> in the navigation bar of your browser

The four physical network ports (Port 1 to 4) are managed by two independent internal network interfaces (NIC 1 / NIC 2).

Port 1 is fixed assigned to NIC 1.

Port 2, 3 and 4 can be assigned to either NIC 1 or NIC 2 on the SWITCH tab - see "Switch" on page 89.



### NOTE

If NIC 1 and NIC 2 are connected to the same switch, they must be configured to different subnets - see "Network Settings" on page 40.

### Default Network Configuration

Port	NIC	IP Address
1*	1	192.168.0.1
2*	2	DHCP
3	switched	as NIC 1
4	switched	as NIC 2

\* attached directly to the NIC



### NOTE

To access the control it is required to connect the management network to one of the ports that is directly attached to a NIC - see "Switch" on page 89

## Status - Overview

The tab 'STATUS' is divided into several sections:

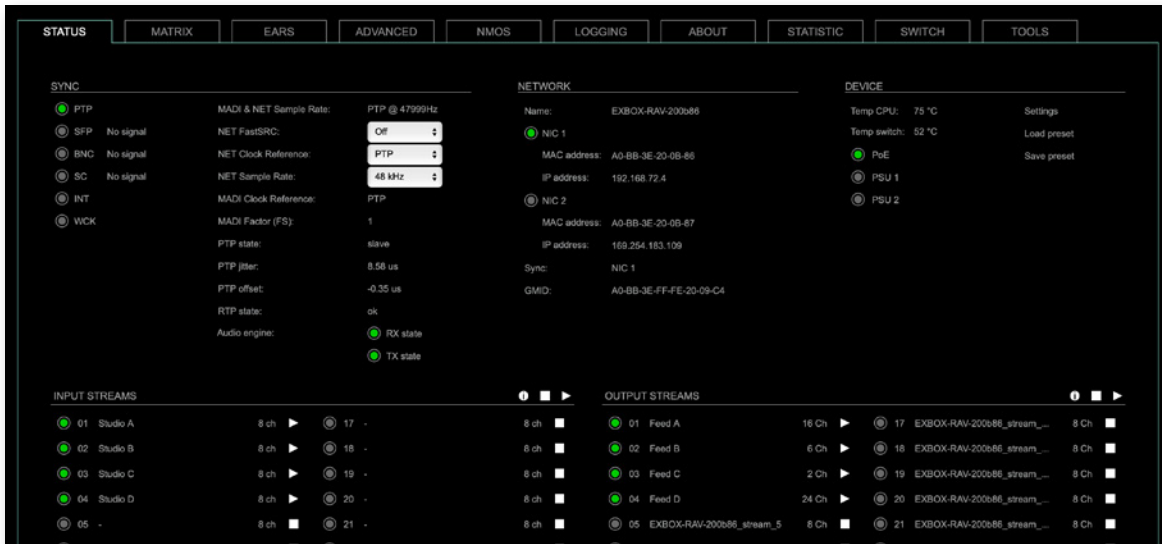

- SYNC - monitoring sync state, clock selection, sample rate conversion, links to I/O settings
- NETWORK - display network info, link to network settings
- DEVICE - monitoring device info, link to device settings, phones level control
- INPUT STREAMS - monitoring and control input streams, link to input stream settings
- OUTPUT STREAMS - monitoring and control output streams, link to output stream settings

Hyperlinks open a popup window to adjust related settings. Most settings are updated immediately without further notification. To exit a popup window click the button in the top right corner.

Mouse overs are used to display further information (e.g. connection speed of network link).

## NOTE

The web user interface updates itself when changes are applied by other instances (other browsers, external control commands).



### Status - Sync

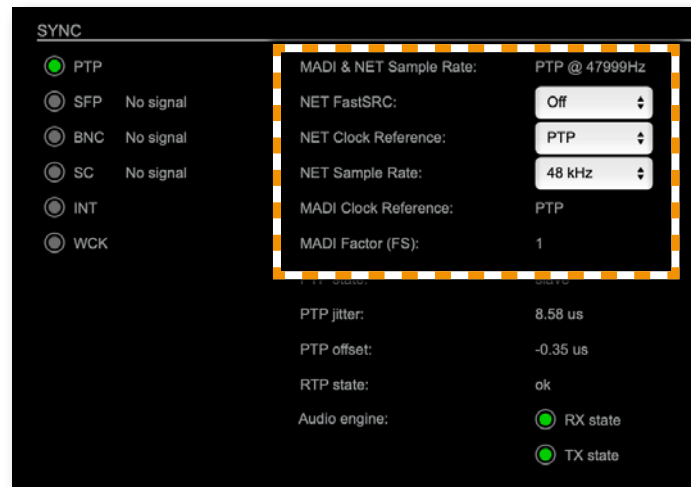

**FastSRC not active**

The LEDs inform about the lock / sync state of each MADI port and the PTP clock.

<p>SYNC PTP SFP BNC SC</p>	<p><b>LED - indicates selected clock source and the lock / sync state of MADI input, PTP-clock or the internal clock generator.</b></p> <p><input type="radio"/> (OFF) = no signal lock</p> <p><input checked="" type="radio"/> (100 % green) = signal lock, in sync, selected clock source</p> <p><input type="radio"/> (blinking red) = signal lock, not in sync with selected clock source</p> <p><input type="radio"/> (blinking green) = input selected as clock source and no signal lock.</p>
<p>SYNC WCK</p>	<p><b>LED - indicates selected clock source and the lock state of the WCK input.</b></p> <p><input type="radio"/> (OFF) = no signal lock</p> <p><input checked="" type="radio"/> (100 % purple) = signal lock, selected clock source</p>
<p>MADI &amp; NET Sample Rate</p>	<p>Displays current clock master and measured sample frequency. If 'NET FastSRC' is active the measured sample frequency of the selected clock reference is displayed.</p>
<p>NET FastSRC</p>	<p><b>Pull-down menu - enabling / disabling of Sample Rate Conversion at RAVENNA I/O **</b></p> <p>OFF = SRC not active</p> <p>ON = SRC active</p>
<p>NET Clock Reference</p>	<p><b>Pull-down menu - selection clock source for network module</b></p> <p>PTP = PTP</p> <p>MADI = MADI port or internal (MADI clock reference)</p>
<p>NET Sample rate</p>	<p><b>Pulldown menu to adjust network sample rate</b></p> <p>Values: 44.1 / 48 / 88.2 / 96 / 176.4 / 192 kHz</p>



**FastSRC active**

#### Hyperlinks

- [PTP / PTP State \(p 38\)](#)

MADI Clock Reference	<p><b>Pull-down menu - selection of clock source (if FastSRC is active)</b></p> <p>Values:</p> <p>PTP = PTP clock (Master or Slave)</p> <p>SFP = MADI SFP input</p> <p>BNC = MADI BNC input</p> <p>SC = MADI SC input</p> <p>INT 44.1 = internal clock generator 44.1 kHz</p> <p>INT 48 = internal clock generator 48 kHz</p> <p>WCK* = Word Clock @ MADI BNC input</p>
MADI Factor (FS)	<p><b>Pull-down menu - selection of scaling factor for all MADI ports (input and output)</b></p> <p>Values: 1 FS, 2 FS, 4 FS</p>

\* Selecting WCK as clock source will change the operating mode of the MADI BNC input, accepting a word clock signal according to AES11 there.

\*\* See „Sample Rate Conversion“ on page 26.



**FastSRC active <-> not active**

FastSRC	Clock NET	Clock Device	PTP state
ON	PTP	MADI, WCK or INT	Master or Slave
OFF	MADI		Master
OFF	PTP	PTP	Master or Slave

With FastSRC active, the device may be clocked independently from the audio network.

With FastSRC not active, the device may act as PTP clock master, the PTP clock is then derived from a MADI or Word Clock input or the internal generator.

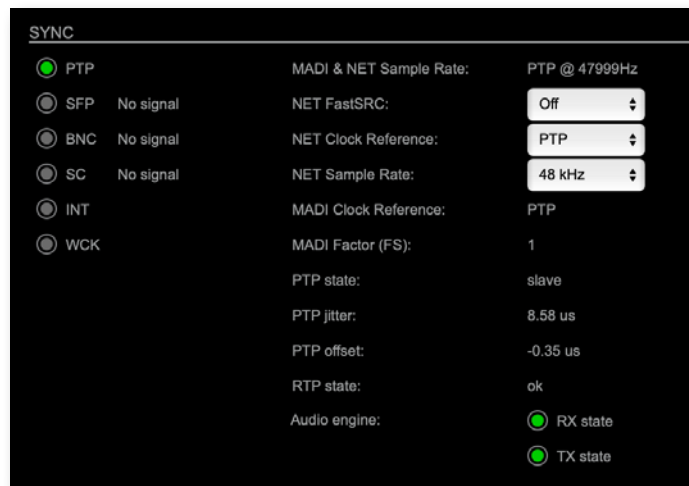

PTP state	State of PTP (Master / Slave).
PTP jitter	PTP-clock jitter per second
PTP offset	Offset relative to PTP-clock master
RTP state	Status of packet processing (OK, Error***)
Audio engine RX state	State of module's audio engine - receiving ● (ON) = ok, receiving data ● (blinking) = not all received packets can be processed
Audio engine TX state	State of module's audio engine - sending ● (ON) = ok, sending data ● (blinking) = not all packets can be sent to the network

\*\*\* Error: packet time stamps are out of bounds.

Possible reasons: stream offset may be too small or transmitter or receiver are not synced properly to the Grandmaster.

### MADI Format, Mode & Bit transparency

On the MADI input channel mode 56 / 57 and 64 channels are detected automatically.

For the MADI output both frame format and channel mode can be set individually. Click on SFP or BNC or SC to open the settings.

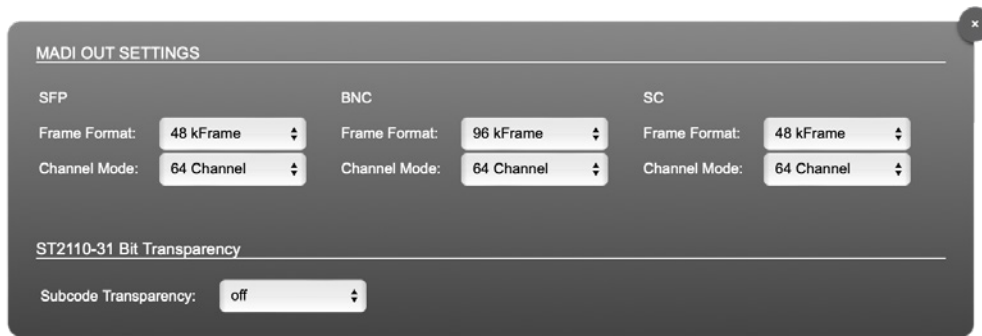

MADI OUT Settings Frame Format	Frame format for MADI output signal (48k / 96k Frame)*
MADI OUT Settings Channel Mode	Channel mode for MADI output signal (56 ch / 57 ch / 64 ch)**
ST2110-31 Bit Transparency Subcode Transparency	off = new subcode data is generated on = incoming subcode is preserved at the output

\* 96k Frame format is applied at 2 FS operation only.

\*\* See See „Appendix C-Working with ch 57 mode“ on page 101.

### Clocking to word clock

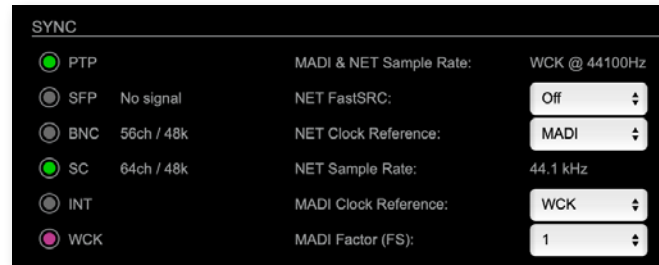

- MADI BNC input expects a word clock signal (AES11)
- BNC input in the routing matrix can still be patched as source, but will not transmit audio.
- EARS™ mode 'NET > BNC' will not work as expected, as the BNC input is not available as backup source.

### PTP Settings

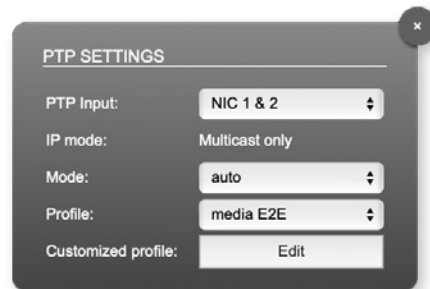

PTP Input	Port selection for PTP clock input. 'NIC 1 & 2' means input redundancy.
IP Mode	PTP via multicast, unicast or in hybrid mode. *
Mode	PTP-clock master / slave configuration is auto negotiated between devices in the network. Selection: auto, slave only, preferred master *
Profile	PTP profile selection (default E2E, default P2P, media E2E, media P2P, customized)
Customized profile	Edit opens the tab 'ADVANCED' to adjust the custom profile.

\* See „Advanced- PTP Clock Setting“ on page 78 for more details.

### Status - Network

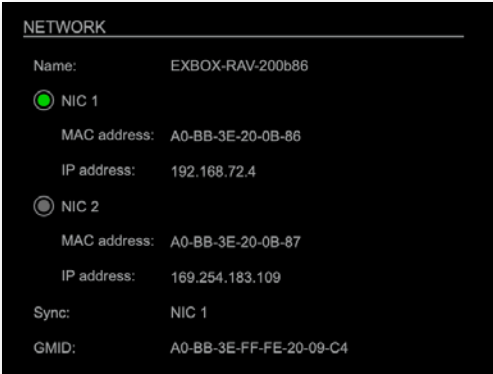

Name	Module’s name in the network. Used e.g. for mDNS service. The name needs to be unique throughout the network.
NIC 1 / NIC 2	Monitoring state of network interface controller (NIC) <input type="radio"/> (OFF) = not connected <input checked="" type="radio"/> (ON) = connected with the network
MAC address	Hardware identification of NIC.
IP address	IP address of device
Sync port	Selected port for PTP sync
GMID	Grand Master ID (PTP)

Hyperlinks  
Name / IP address (p 40)

Mouse over:  
LED NIC 1- indicating link state and connection speed  
LED NIC 2- indicating link state and connection speed

### NOTE



If NIC 1 and NIC 2 are connected to the same switch, they must be configured to different subnets - see "Network Settings" on page 40.

## Network Settings

The two NICs are configured individually.

**NETWORK SETTINGS**

Device name:

---

**NIC 1**

Dynamic IP address (IPv4):

Static IP address (IPv4):

IP address (IPv4):

Subnet mask (IPv4):

Gateway (IPv4):

DNS server (IPv4):

Accept multicast from other subnet:

Direct routing (multicast transfer only):

<input type="checkbox"/>	Host IP address 1:	<input type="text" value="0.0.0.0"/>
<input type="checkbox"/>	Host IP address 2:	<input type="text" value="0.0.0.0"/>
<input type="checkbox"/>	Host IP address 3:	<input type="text" value="0.0.0.0"/>
<input type="checkbox"/>	Host IP address 4:	<input type="text" value="0.0.0.0"/>
<input type="checkbox"/>	Host IP address 5:	<input type="text" value="0.0.0.0"/>
<input type="checkbox"/>	Host IP address 6:	<input type="text" value="0.0.0.0"/>
<input type="checkbox"/>	Host IP address 7:	<input type="text" value="0.0.0.0"/>
<input type="checkbox"/>	Host IP address 8:	<input type="text" value="0.0.0.0"/>
<input type="checkbox"/>	Host IP address 9:	<input type="text" value="0.0.0.0"/>
<input type="checkbox"/>	Host IP address 10:	<input type="text" value="0.0.0.0"/>

**NIC 2**

Dynamic IP address (IPv4):

Static IP address (IPv4):

IP address (IPv4):

Subnet mask (IPv4):

Gateway (IPv4):

DNS server (IPv4):

Accept multicast from other subnet:

Direct routing (multicast transfer only):

<input type="checkbox"/>	Host IP address 1:	<input type="text" value="0.0.0.0"/>
<input type="checkbox"/>	Host IP address 2:	<input type="text" value="0.0.0.0"/>
<input type="checkbox"/>	Host IP address 3:	<input type="text" value="0.0.0.0"/>
<input type="checkbox"/>	Host IP address 4:	<input type="text" value="0.0.0.0"/>
<input type="checkbox"/>	Host IP address 5:	<input type="text" value="0.0.0.0"/>
<input type="checkbox"/>	Host IP address 6:	<input type="text" value="0.0.0.0"/>
<input type="checkbox"/>	Host IP address 7:	<input type="text" value="0.0.0.0"/>
<input type="checkbox"/>	Host IP address 8:	<input type="text" value="0.0.0.0"/>
<input type="checkbox"/>	Host IP address 9:	<input type="text" value="0.0.0.0"/>
<input type="checkbox"/>	Host IP address 10:	<input type="text" value="0.0.0.0"/>

Device name	Input field- Module's name in the network. Used e.g. for mDNS service. The name needs to be unique throughout the network.
Dynamic IP address (IPv4)	Switch to enable the device's DHCP client. IP address is assigned by DHCP server. If no DHCP is available the IP address is determined via Zeroconf.
Static IP address (IPv4)	Switch to disable the device's DHCP client. Manual configuration of network parameters.
IP address (IPv4)	Module's IP Address
Subnet mask (IPv4)	Module's subnet mask
Gateway (IPv4)	IP address of gateway
DNS server (IPv4)	IP address of DNS server
Accept multicast from other subnet	Setting of return path filter (rp filter) to accept or refuse multicast packets from different subnets. Values: yes (default), no
Direct routing	IP addresses of devices outside the subnet, to enable multicast traffic; e.g. Grandmaster or IGMP querier. Mark checkbox to activate.
Apply	Button to confirm changes. A popup window will appear to confirm a reboot of the module.

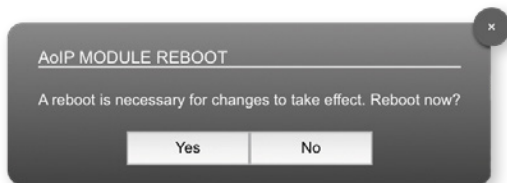

## Status - Device

Information about the current PSU state, access to settings and preset management.

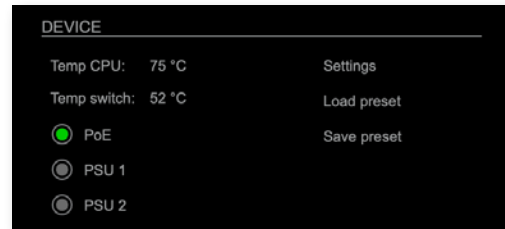

Three LEDs inform about the current state of each PSU individually.

Temp CPU	Display temperature of CPU core in degree Celsius. It may reach 110 °C without effecting the performance of the device.
Temp switch	Display temperature of network switch in degree Celsius
PSU 1, PSU 2, PoE	<p><b>LED indicates state of the power supply.</b></p> <ul style="list-style-type: none"> <li><input type="radio"/> (OFF) = psu not active</li> <li><input checked="" type="radio"/> (100 % green) = psu active</li> <li><input type="radio"/> (blinking yellow) = psu active, after failure*</li> <li><input type="radio"/> (blinking red) = psu not active, after being active before*</li> </ul>
Settings	Opens a popup window to configure the device.
Load preset	Opens a dialog to store the device settings to a file. Filetype: .rps
Save preset	Opens a dialog to restore the device settings from a file. Filetype: .rps

\* To reset the display of the PSU state click on the LED label.



Hyperlinks:

- [Settings \(p 44\)](#)
- [Load preset \(p 45\)](#)
- [Save preset](#)

This page is left blank intentionally.



### Settings

Information about the the device's firmware and the module's software/hardware version and the serial number.

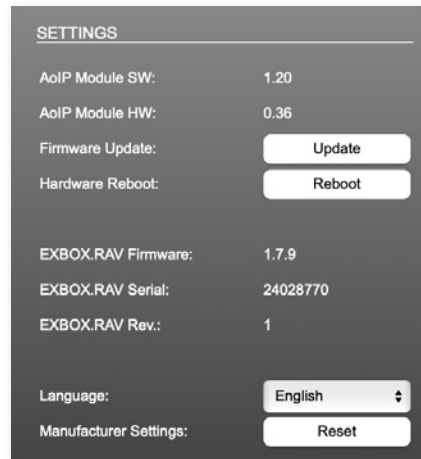

AoIP Module SW*	Module’s software version. It is updated together with hardware version.
AoIP Module HW*	Module’s bitstream version. It is updated together with software version.
Firmware Update	Opens a dialog for selection of the update file - see "Appendix D- Firmware Update" on page 102.
Hardware Reboot	Restart of the AoIP module. Confirmation required. Audio transmission will be interrupted.
EXBOX.RAV Firmware*	Device firmware version
EXBOX.RAV Serial*	Device serial number
EXBOX.RAV Rev.	Device hardware revision- also marked at the rear of the device
Language	Menu language (english, german).
Manufacturer Settings Reset	Restore device settings to factory defaults. Confirmation required.

\* This information is required when contacting DirectOut Support.

## Load Preset

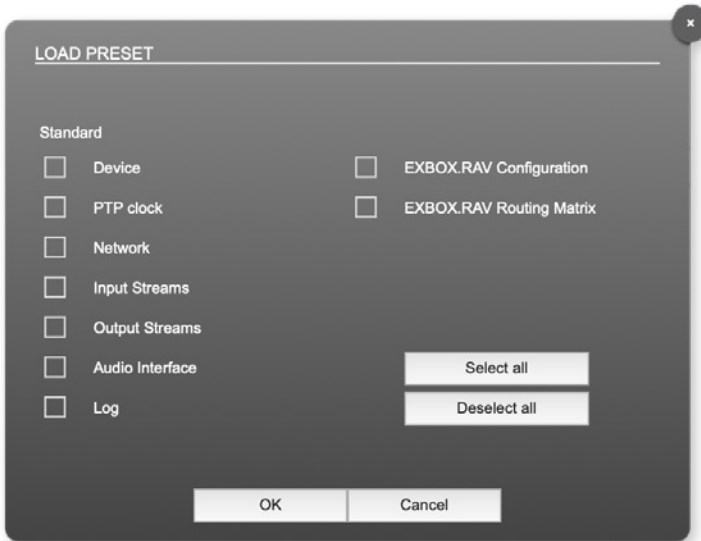

The device configuration can be stored to a single file (.rps). Restoring the configuration a dialog prompts for selection of individual settings. This enhances flexibility at setup changes when a particular adjustment shall be preserved or just a single adjustment shall be restored.

### Status - Input Streams



The module can subscribe up to 32 streams. The overview displays the basic information of each stream. The input stream name can be set manually (discovery protocol: manually, see p 55) overriding the SDP's stream name information.

A backup stream can be defined as source after an adjustable timeout. A central active / inactive switch allows to toggle the stream state of all input streams at once.

01 to 32	<p>State of incoming streams</p> <ul style="list-style-type: none"> <li><input type="radio"/> (OFF) = stream not activated</li> <li><input checked="" type="radio"/> (ON) = stream activated, receiving data</li> <li><input checked="" type="radio"/> (ON) = stream activated, receiving data via one port only (input redundancy)</li> <li><input checked="" type="radio"/> (blinking) = stream activated, not receiving data (unicast, connection not established)</li> </ul>
01 to 32 Name	Name of stream gathered from SDP or set manually in the stream settings dialog.
01 to 32 xx ch	Number of audio channels transported by the stream



01 to 32 	Click to activate or deactivate single stream. = stream activated = stream deactivated = stream not active, defined as backup-stream
INPUT STREAMS 	Click to activate or deactivate all streams. = activate all streams = deactivate all streams (requires confirmation)
INPUT STREAMS 	Click  to display input streams overview

**Input Streams Overview**

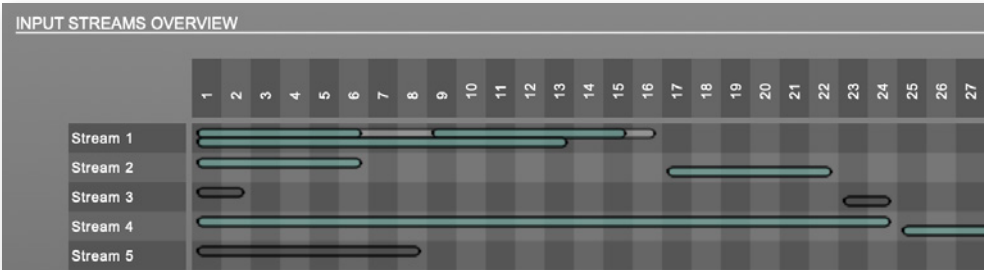

Two displays per stream:

- upper bar = original stream size and selected channels
- lower bar = resulting stream size and position in channel matrix
- green = stream active
- grey = stream not active

Channel selection of Stream 1

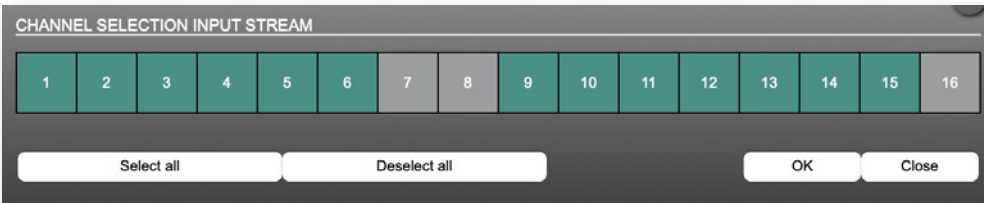

### Backup Streams

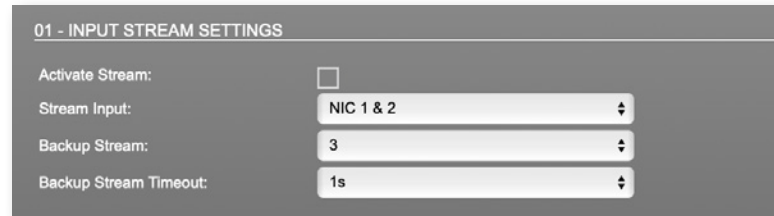

Example:

Backup stream (input 3) that will act as source in the audio matrix if the current session (input 1) fails. Switch-over occurs after the defined timeout (1s). Stream 3 is marked accordingly in the status view

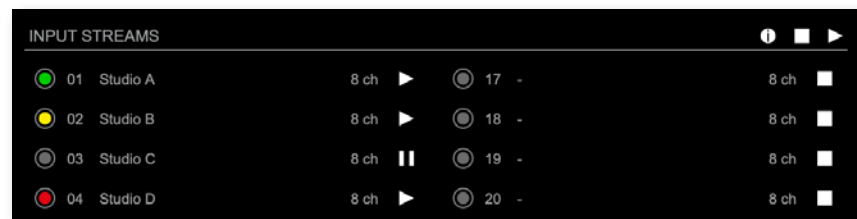

Input 1 failed and Input 3 becomes active after the timeout.



### NOTE

In case the main input fails the main stream is stopped (IGMP LEAVE) before the backup stream is being activated. This behaviour ensures that the required network bandwidth does not increase in case of a failure.

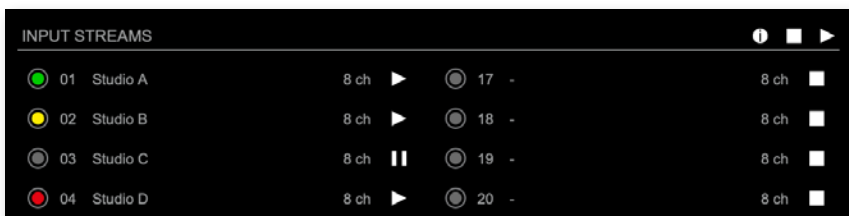

Hyperlinks:

- Name (p 50)

Mouse over:

- LED- indicating stream state

## NOTE

Source-Specific Multicast (SSM) support for IGMP v3, v2 and v1 (SSM via protocol only in IGMP v3, SSM via internal filtering is applied for IGMP v2 and v1) - see "Source Specific Multicast 1" on page 55.



## Input Stream Settings

**01 - INPUT STREAM SETTINGS**

Activate Stream:

Stream Input: NIC 1 ▾

Backup Stream: disabled ▾

Backup Stream Timeout: 1s ▾

Stream name: Studio A

Stream state: not connected

Stream state messages:

Stream state offset max (samples): -

Stream state offset min (samples): -

Stream state ip address src NIC 1 / NIC 2: - / -

Stream state connection lost (Events) NIC 1 / NIC 2: 0 / 0

Stream state packet lost (Events) NIC 1 / NIC 2: 0 / 0

Stream state wrong timestamp (Events) NIC 1 / NIC 2: 0 / 0

Stream state syntonous sync: -

Syntonous mode enable:

Offset fine:

Offset in samples: 128 (2.666 ms) ▾

Start channel: 1 ▾

Audio Channel Selection: select

Discovery protocol: RTSP (RAVENNA Session) ▾

Session NIC 1: Studio A@NIC 1 ▾

Session NIC 2: ▾

Up to 32 input streams can be subscribed. Each stream is organized in a 'RAVENNA session' (SDP = Session Description Protocol) that describes the stream parameters (audio channels, audio format, etc.).

The stream settings allow to adjust the processing of the received audio data (offset, signal routing). The receiving of stream data starts once the stream has been enabled.

The settings displayed vary depending on the selected discovery protocol.



### TIP

A sample offset of at least doubled packet time (samples per frame) is recommended

Example: Samples per frame = 16 (0.333 ms) ⇔ Offset ≥ 32 (0.667 ms)

It may be helpful to alter the stream discovery protocol if an expected stream can't be discovered by the device.

Activate stream	Stores parameters and activates or deactivates the receiving of audio data. (Unicast: additionally the negotiation of the connection)
Stream input	Selects one or both NICs used for stream input. Both NICs means input redundancy.
Backup Stream	Selects a backup stream that will act as source in the audio matrix if the current session fails. Switch-over occurs after the defined timeout.
Backup Stream Timeout	Defines timeout [1 s to 120 s] before switch-over to backup stream.
Stream name	Name of stream gathered from SDP
Stream state	Information about stream state: connected not connected receiving data read successfull error
Stream state message	Status info related to stream state.
Stream state offset max	Measured value (maximum). A high value indicates that the media offset of the source might not match the adjusted media offset of the device.
Stream state offset min	Measured value (minimum). The offset should not become negative.
Stream state ip address src NIC 1 / NIC 2	Multicast address of input stream subscribed at NIC 1 / NIC 2. Unicast transmission: IP address of sender.
Stream state connection lost (Events) NIC 1 / NIC 2	counter indicates the number of incidents where the network connection was lost (link down)
Stream state packet lost (Events) NIC 1 / NIC 2	counter indicates the number of lost RTP packets
Stream state wrong timestamp (Events) NIC 1 / NIC 2	counter indicates the number of packets with invalid timestamp
Stream state syntonous sync	Displays that the NIC has synchronized to the stream.
Syntonous mode enable	Enables syntonous streaming, synchronisation of senders and receivers must be granted by other means than PTP.



Offset fine	Enables adjustment of offset in increments of one sample.
Offset in samples	Modules output delay of received audio data (input buffer).
Start channel	Assignment of first stream channel in the audio matrix. E.g. stream with two channels, starting at channel 3 is available at channel 3 & 4 of the routing matrix.
Audio Channel Selection	Single channels can be picked from a stream, if a stream transports more audio channels than needed or contains 'empty' audio channels.
Discovery protocol	Connection protocol or manual configuration. RTSP = Real Time Streaming Protocol NMOS = Networked Media Open Specifications SAP = Session Announcement Protocol
Session NIC 1	Selection of discovered streams at NIC 1
Session NIC 2	Selection of discovered streams at NIC 2

### Audio Channel Selection

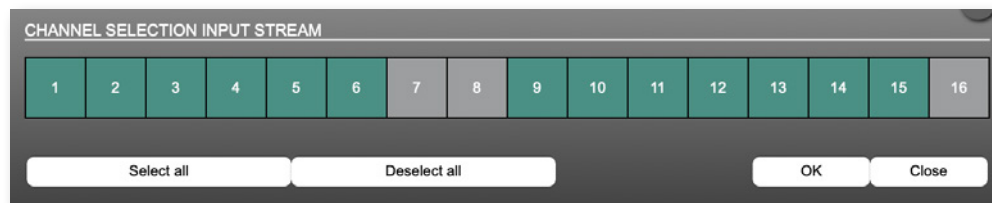

green = channel is received and used

grey = channel is ignored

'Start channel' and 'Audio Channel Selection' define the channel mapping in the routing matrix. The channel mapping is display in the "Input Streams Overview" on page 47.

Stream Discovery in AoIP environments is a colorful mixture of different mechanisms. To serve a successful stream management EXBOX.RAV provides a bunch of options, not making operation easier but effective.

### Discovery RTSP (Session)

### Discovery RTSP (URL)

URL	URL (Uniform Resource Locator) of the session of the device that is serving streams. Examples: rtsp://192.168.72.44/by-id/1 or rtsp://MC-RAV-IO.local:80/by-name/Stage%20A
Receive SDP	Recalls the stream configuration of the defined session(s).

## NOTE

In case the automatic stream announcement and discovery of RAVENNA streams fails or cannot be used in a given network, the stream's SDP file can also be obtained via an RTSP URL.



### Discovery SAP

Discovery protocol: SAP (Dante/AES67 Session) ↓

Session NIC 1: ↓

Session NIC 2: Stage A@NIC 2 ↓

SAP is used in Dante environments.

### Discovery NMOS

Discovery protocol: NMOS ↓

Session NIC 1: ↓

Session NIC 2: [20079e]2] Ambience@NIC 2 ↓ Refresh

Session	[MAC Address of sender] stream name @NIC
Refresh	Initiates a scan for available streams.

NMOS is suited for use in SMPTE ST 2110 environments.

## Manual Setup

Discovery protocol: Manual configuration Import SDP file Import SDP

Stream name (manual):

Number of channels: 8

RTP payload ID: 98

Audio format: L24

Media offset:

---

**NIC 1**

Dst IP address:

SSM (Source Specific Multicast):

Src IP address:

RTP dst port:

RTCP dst port:

**NIC 2**

Dst IP address:

SSM (Source Specific Multicast):

Src IP address:

RTP dst port:

RTCP dst port:

Stream name (manual)	Stream name for display in status view and matrix. Can be specified individually, different than the name gathered from the SDP.
Number of channels	Number of audio channels in the stream
RTP-Payload-ID	RTP-Payload-ID of the audio stream (Real-Time Transport Protocol). Describes the format of the transported content.
Audio Format	Stream's audio format (L16 / L24 / L32 / AM824)
Media Offset	Offset between stream's timestamp and PTP-clock
Dst IP address	Multicast IP address of audio stream
SSM (Source Specific Multicast)	Activate Source Specific Multicast filter for this stream.*
Src IP address	IP address of sending device.*
RTP dst port	Stream's destination port for RTP
RTCP dst port	Stream's destination port for RTCP (Real-Time Control Protocol)

\* An RTP packet contains the IP address of the sender (source IP) and the stream's multicast address (destination IP). With SSM activated the receiver only accepts RTP packets of a certain destination IP that are originated by a sender with the specified source IP.

### NOTE



RTP Payload ID must match between sender and receiver.

### Session Description Protocol

Stream discovery set to 'Manual configuration' requires to define the stream parameters manually or to import an SDP data via .sdp-file or prompt.

Import SDP File	Imports SDP data from .sdp file
Import SDP	Imports SDP data from a prompt

Example of SDP data:

```
v=0
o=- 1 3144252155 IN IP4 192.168.72.82
s=Studio A
t=0 0
m=audio 5004 RTP/AVP 98
i=Stream 1
c=IN IP4 239.69.1.1/128
a=source-filter: incl IN IP4 239.69.1.1 192.168.72.82
a=rtpmap:98 L24/48000/8
a=sync-time:0
a=clock-domain:PTPv2 0
a=framecount:48
a=recvonly
a=mediaclk:direct=0
a=ts-refclk:ptp=IEEE1588-2008:A0-BB-3E-FF-FE-20-09-C4:0
a=ptime:1
a=maxptime:1
```



### TIP

The SDP data of an output stream can be copied from the output stream settings.

This page is left blank intentionally.

### Status - Output Streams

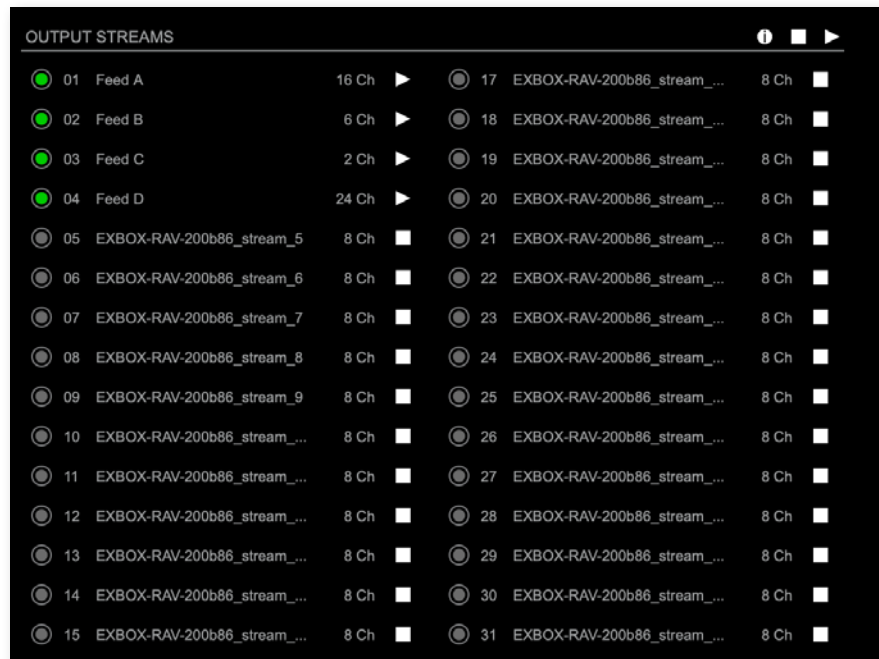

The device can send up to 32 streams. The overview displays the basic information of each stream.

01 to 32	State of outgoing streams <input type="radio"/> (OFF) = stream not activated <input checked="" type="radio"/> (ON) = stream activated, sending data <input checked="" type="radio"/> (ON) = stream activated, stream output via both ports selected, but one port is not linked to the network.
01 to 32 Name	Name of stream defined in the settings
01 to 32 xx ch	Number of audio channels transported by the stream
01 to 32 ■ ▶	Activate or deactivate stream. ▶ = stream activated ■ = stream deactivated
OUTPUT STREAMS ■ ▶	Click to activate or deactivate all streams. ▶ = activate all streams ■ = deactivate all streams (requires confirmation)
OUTPUT STREAMS i	Click <b>i</b> to display output streams overview

Hyperlinks:

- Name (p 60)

Mouse over:

- LED- indicating stream state

## Output Streams Overview

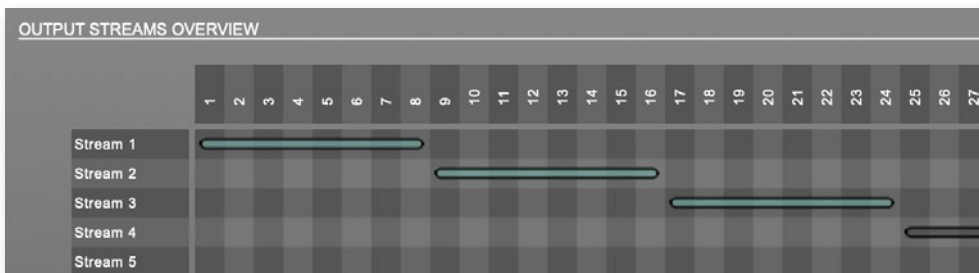

Bars informing about stream size and position in channel matrix.

green = stream active

grey = stream not active

## TIP



AES67 Streams

To create output streams for interoperability in AES67 environments please consult the information document [Info- AES67 Streams](#).

## TIP



SMPTE 2110-30 /-31 Streams

To create output streams for interoperability in SMPTE ST 2110 environments please consult the information document [Info- ST2110-30 Streams](#).

Both documents are available at <http://academy.directout.eu>.



## Output Stream Settings

**01 - OUTPUT STREAM SETTINGS**

Activate Stream:

Stream Output: NIC 2

Stream name (ASCII): Talkback OB to Stage A

RTSP URL (HTTP tunnel) (by-name): rtsp://EXBOX-RAV-200b86.local:80/by-name/Talkback%20OB%20to%20Stage%20A

RTSP URL (HTTP tunnel) (by-id): rtsp://EXBOX-RAV-200b86.local:80/by-id/1

RTSP URL (by-name): rtsp://EXBOX-RAV-200b86.local/by-name/Talkback%20OB%20to%20Stage%20A

RTSP URL (by-id): rtsp://EXBOX-RAV-200b86.local/by-id/1

SDP:

Unicast:

RTP payload ID: 98

Samples per Frame (packet time): 48 (1.00 ms)

Audio format: L24

Start channel: 1

Number of channels: 8

NIC 1	NIC 2
RTP dst port: <span style="border: 1px solid #ccc; padding: 2px;">5004</span>	RTP dst port: <span style="border: 1px solid #ccc; padding: 2px;">5004</span>
RTCP dst port: <span style="border: 1px solid #ccc; padding: 2px;">5005</span>	RTCP dst port: <span style="border: 1px solid #ccc; padding: 2px;">5005</span>
Dst IP address (IPv4): <span style="border: 1px solid #ccc; padding: 2px;">239.69.1.1</span>	Dst IP address (IPv4): <span style="border: 1px solid #ccc; padding: 2px;">239.69.1.2</span>

Up to 32 output streams can be sent to the network. Each stream is organized in a session (SDP = Session Description Protocol) that describes the stream parameters (audio channels, audio format, etc.).

Each stream may be labelled with an individual stream name (ASCII) which is useful for enhanced comfort at organizing the setup.

The stream settings allow to adjust the processing of the sent audio data (blocks per frame, format, signal routing, ...). The sending of stream data starts once the stream has been enabled.

Once the stream is active, the SDP data is displayed and may be copied from the window or downloaded via <http://<exbox-rav>/sdp.html?ID=<stream no.>>.

Activate stream	Stores parameters and activates or deactivates the receiving of audio data. (Unicast: additionally the negotiation of the connection)
Stream Output	Selects one or both NICs used for stream output. Both NICs means output redundancy.
Stream name (ASCII)	Individually defined name of an output stream. It is used in the URL which is indicated in different ways below.*
RTSP URL (HTTP tunnel) (by-name) / (by id)	Current used RTSP-URL of stream with HTTP port used for RTSP, stream name or stream id.
RTSP URL (by-name) / (by id)	Current used RTSP-URL of stream with stream name or stream id.
SDP	SDP data of the active stream.
Unicast	If activated, the stream is sent in unicast mode.**
RTP payload ID	Stream's payload id
Samples per Frame	Number of blocks containing payload (audio) per ethernet frame - see packet time on p 50.
Audio format	Stream's audio format (L16 / L24 / L32 / AM824) ***
Start channel	Assignment of first stream channel from the audio matrix. E.g. stream with eight channels, starting at channel 3 is fed from channel 3 to 10 of the routing matrix.
Number of channels	Number of audio channels in the stream.
RTP dst port	Stream's destination port for RTP
RTCP dst port	Stream's destination port for RTCP (Real-Time Control Protocol)
Dst IP address (IPv4)	Stream's IP address for multicast (should be unique for each stream).

\* Only ASCII characters are allowed.

\*\* A unicast stream can only be received by one device. If a device is already receiving the stream, further connection calls by other clients are answered with 'service unavailable' (503). The release time after disconnect or interruption of the client's connection amounts to about 2 minutes.

\*\*\* L16 = 16 bit audio / L24 = 24 bit audio / L32 = 32 bit audio / AM824 = standardized according to IEC 61883, allows AES3 transparent transmission (SMPTE ST 2110-31).

### Matrix

The tab 'MATRIX' manages 192 MADI channels (SFP, BNC, SC) and 64 network channels (RAVENNA).

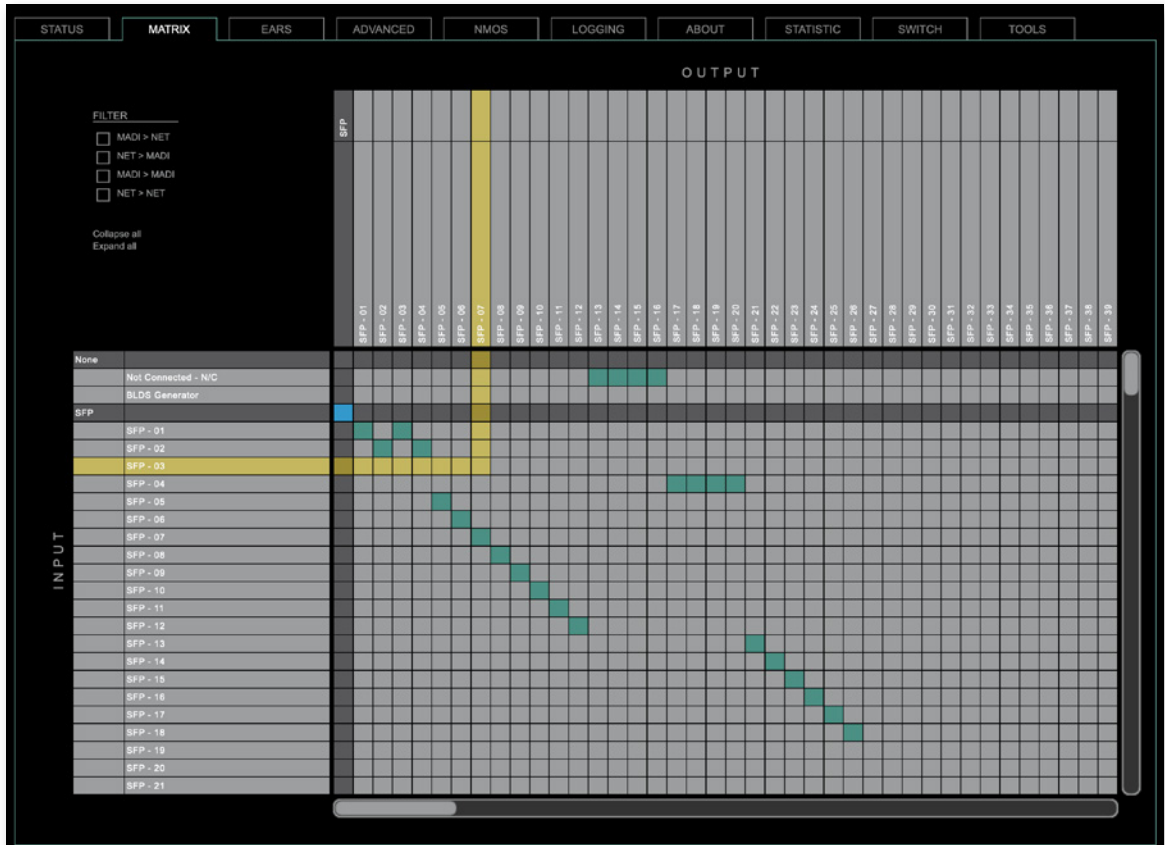

### Organisation

- Inputs - vertical column
- Outputs - horizontal row
- Click on SFP, BNC, SC or NET to expand or collapse the corresponding i/o.

### Filter

Viewing filters can be applied to focus on used areas for patching.

MADI > NET	MADI inputs and NET outputs
NET > MADI	NET inputs and MADI outputs
MADI > MADI	MADI inputs and MADI outputs
NET > NET	NET inputs and NET outputs
Collapse all	all i/os collapsed
Expand all	all i/os expanded

**Patching**

- A yellow crossline marks the hotspot for setting a patch.
- Patches are marked by a green square.
- To set a patch  
Move the hotspot to the desired position + Click
- To delete a patch  
Move the hotspot up to  
,Not Connected- NC' + Click  
or  
ALT + Click the current patch
- Multi-channel patches (diagonal and horizontal):  
SHIFT + Click start + Click end
- Multi-channel patches to N/C  
ALT + SHIFT + Click start + Click end
- The blue square allows for quick 1:1 patches per port using CTRL + Click and CTRL + ALT + Click to set all outputs to 'not connected'.

**BLDS Generator**

BLDS Generator is a signal generator for the trigger signal BLDS which is used for the Enhanced Automatic Redundancy Switch (see "EARS™" on page 64).

- Patch a BLDS signal to channel 64 of a physical output that is connected to a device with EARS activated (receiver).
- The presence of the BLDS at the receiver states a valid signal condition from the sender to the receiver.
- If the BLDS signal is corrupted, EARS in the receiver may switch over to the fallback source - inaudible and within one sample.

## EARS™

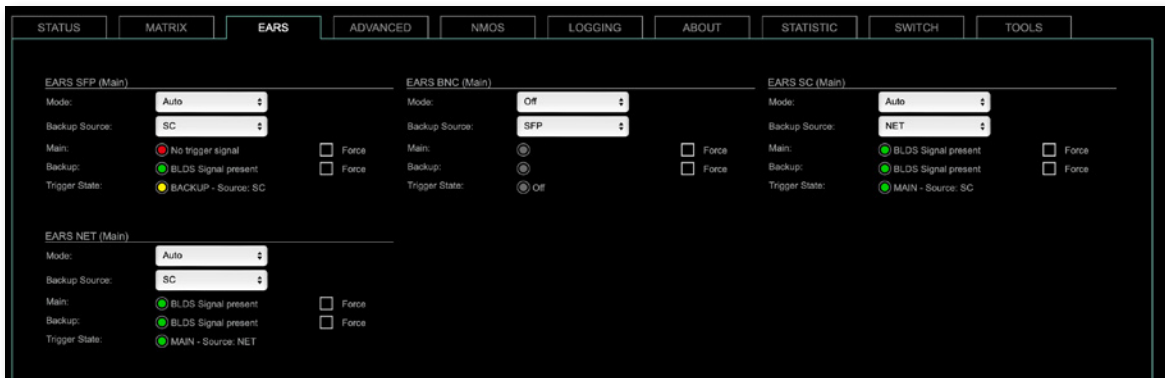

EARS™ (Enhanced Automatic Redundancy Switching) is a system to prevent interruption of the output signal. It uses either the proven BLDS™ technology or pilot tone triggering. A logic monitors the condition of the trigger signal on the input. In case of a failure it switches automatically to the backup input.

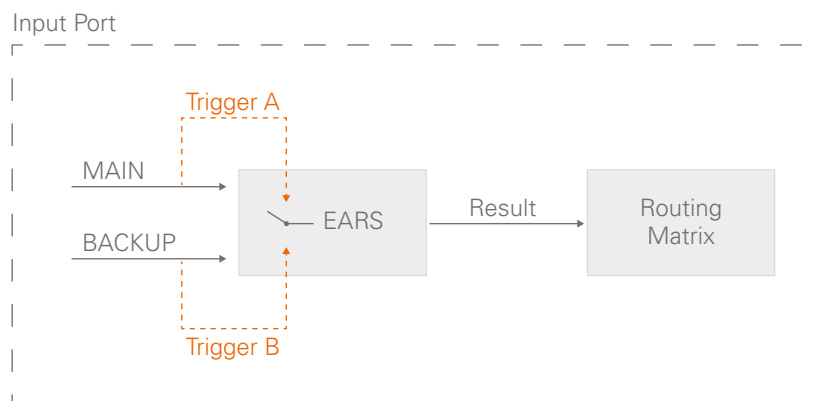

The result of the logic is used as signal source in the routing matrix.

To override automatic switching temporarily the source can be forced to MAIN or BACKUP.



### TIP

Ports defined as BACKUP can also be used independent from EARS for further signal routing.

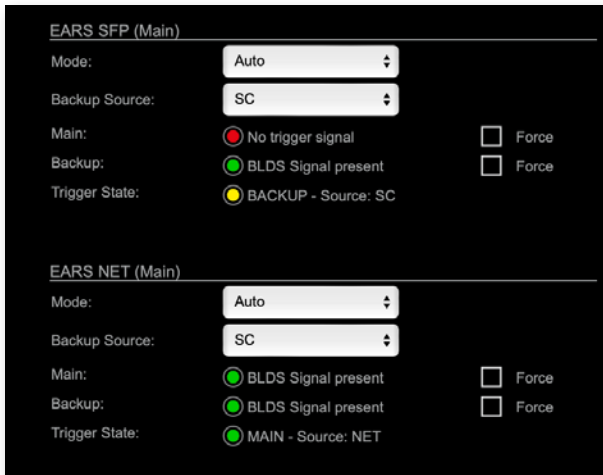

EARS is available for all four input ports (BNC, SC, SFP, NET) and with full routing support.

The signal source for BACKUP can be selected (Backup Source- page 62).

The signal status of the trigger signal and the switching result (Trigger State- page XX) is displayed by leds.

MAIN or BACKUP can be prioritized or set to 'Auto' (Modes- page XX).

To override automatic switching temporarily the source can be forced to MAIN or BACKUP (Force- page XX).

### EARS™ - Backup Source

For each I/O port a backup source is selected via a pull-down menu.

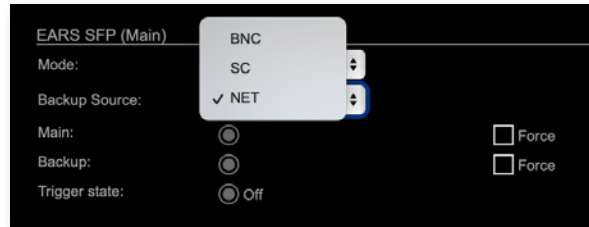

The NET port (RAVENNA) offers an additional mode where:

- MAIN is sourced by NET channel 1 to 32
- BACKUP is sourced by NET channel 33 to 64

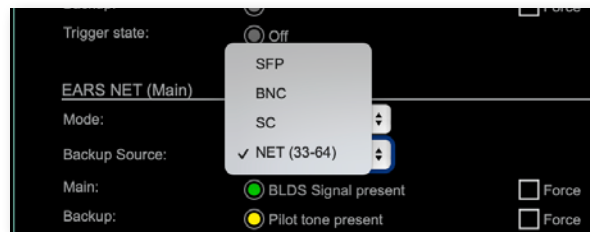

Trigger signals are expected at the 'last audio channel' of signal source - see XX

**EARS™ - Modes**

EARS can be activated for each I/O port individually.  
Activation and the priority behavior is adjusted via a pull-down menu.



OFF	EARS is not active
Prio Main	EARS is active, MAIN is prioritized*
Prio Backup	EARS is active, BACKUP is prioritized*
Auto	EARS is active, automatic port selection, switch-over when required, no revert

\* trigger signal must be identical, BLDS™ has priority over pilot tone.

Example: Prio MAIN, but BACKUP selected

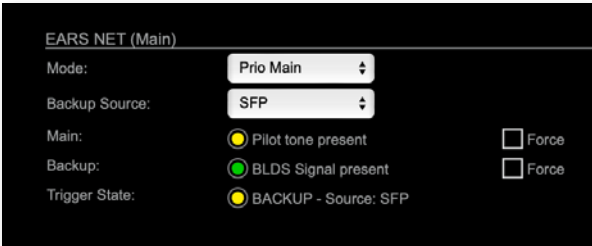



**EARS™ - Triggering**

The device supports two kinds of trigger signals:

- BLDS™ (generated by the BLDS™ Generator)
- Pilot tone (audio signal with a level higher than -40 dBFS).

Switching by BLDS™ trigger is immediate (between two samples). The Pilot tone is evaluated for 10 ms before switching is triggered.

Trigger signals are expected at the 'last audio channel' of the signal source:

Trigger expected	1 FS	2 FS	4 FS
BNC / SC / SFP / NET*	ch 64	ch 32	ch 16
NET (33-64)**	ch 32 / 64	ch 16 / 32	ch 8 / 16

\* ch 56 / 28 / 14 using MAD1 channel mode 56 ch

\*\* available only for NET



**NOTE**

With the FastSRC™ activated at the NET I/O the trigger signal detection of EARS™ is limited to Pilot tone - see "Sample Rate Conversion" on page 26.

**Trigger State / Priorities**

BLDS™ has priority over pilot tone: 'BLDS™' > 'Pilot tone' > 'no trigger'

Switching result table

Main	Backup	Output (Result)
● BLDS™	● BLDS™	● Main
● BLDS™	● pilote tone	● Main
● BLDS™	⊛ no trigger	● Main
● pilote tone	● BLDS™	● Backup
● pilote tone	● pilote tone	● Main
● pilote tone	⊛ no trigger	● Main
⊛ no trigger	● BLDS™	● Backup
⊛ no trigger	● pilote tone	● Backup
⊛ no trigger	⊛ no trigger	● Main

The priority setting ("Modes" on page 67) effects only when the trigger signals at both sources are identical (e.g. both BLDS).

**EARS™ - Force**

To override automatic switching temporarily, the source for the output can be forced to MAIN or BACKUP.

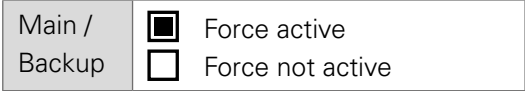

**TIP**



Force Mode can be helpful to stay with one system as a source while testing the second one.

**EARS™ - Status Display**

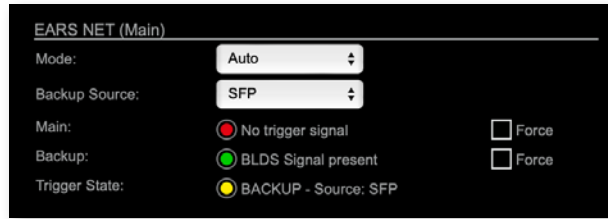

Main	<p><b>LED indicates state of trigger signal in audio channel 64 (or channel 32*)</b></p> <p> <input type="radio"/> (OFF) = no trigger expected  <input checked="" type="radio"/> (100 % green) = BLDS™ signal present  <input type="radio"/> (100 % yellow) = Pilot tone present  <input checked="" type="radio"/> (blinking red) = no trigger signal         </p>
Backup	<p><b>LED indicates state of trigger signal in audio channel 64.</b></p> <p> <input type="radio"/> (OFF) = no trigger expected  <input checked="" type="radio"/> (100 % green) = BLDS™ signal present  <input type="radio"/> (100 % yellow) = Pilot tone present  <input checked="" type="radio"/> (blinking red) = no trigger signal         </p>
Trigger state	<p><b>LED indicates switching result of logic</b></p> <p> <input type="radio"/> (OFF) = standard routing active  <input checked="" type="radio"/> (100 % green) = both or no trigger signals detected, MAIN input active  <input type="radio"/> (100 % yellow) = Backup trigger active, BACKUP input active         </p>

\* NET divided in to 32 + 32 channels - see page 66.

This page is left blank intentionally.

## Advanced - Overview

The screenshot displays the 'ADVANCED' configuration tab for PTP settings. The interface is dark-themed and contains several sections:

- PTP SETTINGS:** PTP Input: NIC 1; IP mode: Multicast; Mode: auto; Profile: default E2E.
- PTP UNICAST:** Auto Detect GM: on; Grant duration (sec): 30; Grandmaster IP: 0.0.0.0.
- PTP CLOCK SETTINGS:** No PTP switch 1 Gbit/s: 0; No PTP switch 100 Mbit/s: 0.
- PTP CURRENT SETTINGS:** Clock class: 248; Accuracy: 254; Clock domain: 0; Clock domain NIC 1: 0; Clock domain NIC 2: 1; Priority 1: 128; Priority 2: 128; Announce: 2 s (1); Sync: 1 s (0); Min delay request: 1 s (0); Min pdelay request: 1 s (0); Announce receipt timeout: 3; One step clock: no; Slave only: no; Delay mechanism: E2E.
- CURRENT PTP MASTER:** Clock class: 248; Accuracy: 254; Clock domain: 0; Priority 1: 128; Priority 2: 128; GMID: A0-B8-3E-FF-FE-20-09-C4; Sync: NIC 1; IPv4: 192.168.72.82.
- PTP STATISTIC:** PTP state: slave; PTP jitter: 0.25 us; PTP offset: -0.03 us; PTP master to slave: 0s 5374ns; PTP slave to master: 0s 5319ns; Current PTP time (TAI): 1970-01-01 00:13:54; Current PTP time (TAI) (RAW): 834s 428775312ns.
- NETWORK ADVANCED SETTINGS:** IGMP NIC 1: auto; IGMP NIC 2: auto; TCP port HTTP: 80; TCP port RTSP: 554; TTL RTP packets: 128; DSCP RTP packets: AF41 (Dx2D); DSCP PTP packets: CS6 (Dx30); Multi stream rx: yes; MDNS announcement: RX/TX; SAP announcement: RX/TX; Multicast audio loopback: no; Multicast RTCP: yes; Network settings: Apply.
- PTP JITTER:** A line graph showing jitter over time. The y-axis ranges from -3826 ns to 3826 ns. The x-axis shows time from -4 min to 0 min. The graph shows a sharp spike in jitter around -4 min, reaching approximately 3826 ns.

The tab 'ADVANCED' is divided into several sections:

- PTP SETTINGS - definition of PTP source, mode and profile
- PTP PROFILE CURRENT SETTINGS - definition of a customized PTP profile
- CURRENT PTP MASTER - monitoring PTP characteristics
- PTP STATISTIC - monitoring device's PTP state, jitter and delay
- PTP CLOCK SETTINGS - definition of adaption algorithms to reduce jitter
- NETWORK ADVANCED SETTINGS - definition of network and QoS characteristics
- PTP JITTER - graphical display of measured PTP jitter

## Advanced - PTP Settings

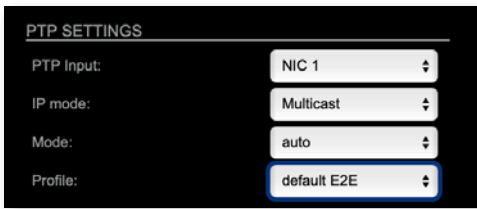

PTP Input	Selects one or both NICs used for PTP input. Both NICs means input redundancy. *
IP Mode	<p>Multicast = Sync messages and delay request are sent as multicast message to every node within the network.</p> <p>Hybrid = Sync messages are sent as multicast, delay requests are sent as unicast messages directly to the Grandmaster or Boundary Clock.**</p> <p>Unicast = Sync messages are sent as unicast, delay requests are sent as unicast messages directly to the Grandmaster or Boundary Clock.***</p>

\* Using redundant PTP-operation a switch-over is triggered not only at signal loss of the Grandmaster but depends on the quality of the PTP clock. Changes (e.g. clock class) are observed permanently and the algorithm decides for the best signal present.

\*\* Hybrid Mode reduces the workload for all nodes in the network as they do not receive the (unnecessary) delay requests from other devices anymore.

\*\*\* Unicast Mode may help when multicast routing is not possible within the network. As an opposite to the Hybrid Mode it increases the workload of the grandmaster since sync messages must be sent to each single slave individually.

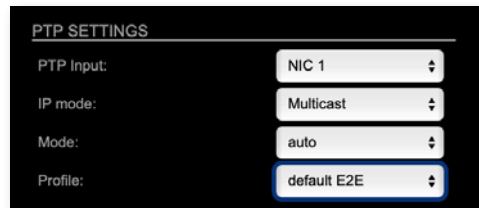

Mode	<p>auto = PTP-clock master / slave configuration is auto negotiated between devices in the network. Module's master / slave state may change automatically.</p> <p>slave only = PTP-clock slave configuration is preferred. Module clocks to another device in the network</p> <p>preferred master = PTP-clock master configuration is preferred. Module acts as network grandmaster. Priority values are adjusted automatically to ensure Grandmaster status. *</p> <p>master only = PTP-clock master is forced. **</p>
Profile	Selects predefined PTP profile (default E2E, default P2P, media E2E, media P2P) or activates customized PTP profile.

\* If more than one device announces as PTP-clock master the network Grandmaster is determined following the Best Master Clock Algorithm (BMCA).

\*\* 'Master only' configures the device to act as Unicast Grandmaster. This setting is available only with PTP Mode set to 'unicast'



### NOTE

PTP profile ,customized' allows for individual adjustment of the PTP parameters. If profile is set to ,media' or ,default' the PTP parameters cannot be altered and are displayed only. Factory default setting is PTP Media Profile E2E.

## Advanced - PTP Unicast



Auto Detect GM	on = enables the automatic detection of the grandmaster * off = IP address of grandmaster needs to be defined manually
Grant duration (sec)	Time period during which the slave receives sync messages from the grandmaster.**
Grandmaster IP	IP address of the grandmaster.***

\* 'Auto Detect GM' is a proprietary function and might not be supported by 3rd party GMs.

\*\* Depending on the temporary workload of the grandmaster the negotiation may fail.

\*\*\* This value is used only with 'Auto Detect GM' set to <off>.

### About PTP Unicast

Since the BMCA is not available with PTP unicast, the PTP properties of the devices require some extra configuration.

Example:

Grandmaster	IP Mode Unicast, Mode Master only
Slave(s)	IP Mode Unicast, Mode Slave Only, Auto Detect GM ON, Grant Duration 30 sec



## Advanced - PTP Profile Customized Settings

PTP CURRENT SETTINGS	
Clock class:	248
Accuracy:	254
Clock domain NIC 1:	0
Clock domain NIC 2:	1
Priority 1:	128
Priority 2:	128
Announce:	2 s (1) ↓
Sync:	1 s (0) ↓
Min delay request:	8 s (3) ↓
Min pdelay request:	8 s (3) ↓
Announce receipt timeout:	3 ↓
One step clock:	no ↓
Slave only:	no ↓
Delay mechanism:	E2E ↓

The settings become available with PTP profile set to 'customized'.

Clock class	PTP-clock's class according to IEEE 1588 [read only]
Accuracy	PTP-clock's accuracy according to IEEE 1588 [read only]
Clock domain NIC 1	PTP-clock's domain at NIC 1
Clock domain NIC 2	PTP-clock's domain at NIC 2
Priority 1	Priority setting for master announcement (the smaller the value the higher the priority)
Priority 2	If value 'Priority1' (and other PTP-clock parameters) of more than one device in the network match: Priority setting for master announcement (the smaller the value the higher the priority)
Announce	Intervall of sending announce-packets for auto-negotiation.

PTP CURRENT SETTINGS	
Clock class:	248
Accuracy:	254
Clock domain NIC 1:	0
Clock domain NIC 2:	1
Priority 1:	128
Priority 2:	128
Announce:	2 s (1) ↓
Sync:	1 s (0) ↓
Min delay request:	8 s (3) ↓
Min pdelay request:	8 s (3) ↓
Announce receipt timeout:	3 ↓
One step clock:	no ↓
Slave only:	no ↓
Delay mechanism:	E2E ↓

Sync	Intervall of sending sync-packets to the PTP-clock slaves in the network.
Min delay request	Intervall of sending End-To-End packets of PTP-clock slave to PTP-clock master. To determine the offset slave-to-master.
Min pdelay request	Intervall of sending Peer-To-Peer packets between two PTP-clocks. To determine the offset master-to-slave and slave-to-master.
Announce receipt timeout	Number of missed announce-packets (threshold) to reinitialize the negotiation of PTP-clock master.
One step clock	Timestamp of PTP-clock is integrated in PTP-sync-packets. No follow-up packets are sent. No = Two step clock is used
Slave only	PTP-clock is always slave.
Delay mechanism	E2E- Offset slave-to-master is determined by End-To-End packets. P2P- Offset master-to-slave and slave-to-master is determined by Peer-To-Peer packets.

### Advanced - Current PTP Master

CURRENT PTP MASTER	
Clock class:	248
Accuracy:	254
Clock domain:	0
Priority 1:	128
Priority 2:	128
GMID:	A0-BB-3E-FF-FE-20-09-C4
Sync:	NIC 1
IPv4:	192.168.72.82

Monitoring display only.

Clock class	PTP-clock's class according to IEEE 1588
Accuracy	PTP-clock's accuracy according to IEEE 1588
Clock domain	PTP-clock's domain at selected input port
Priority 1	Priority setting for master announcement (the smaller the value the higher the priority)
Priority 2	If value 'Priority1' (and other PTP-clock parameters) of more than one device in the network match: Priority setting for master announcement (the smaller the value the higher the priority)
GMID	ID of current Grandmaster
Sync	Selected NIC for PTP clock
IPv4	IP address of Grandmaster

### Advanced - PTP Clock Setting

PTP CLOCK SETTINGS	
No PTP switch 1 Gbit/s:	0
No PTP switch 100 Mbit/s:	0

No PTP Switch 1 Gbit/s	Adapted PTP-clock algorithm to reduce clock jitter using 1 GB network switches without PTP support. Max. number of 1 Gbit/s switches: less than 10
No PTP Switch 100 Mbit/s	Adapted PTP-clock algorithm to reduce clock jitter using 100 MB network switches without PTP support. Max. number of 100 Mbit/s switches: 1

## Advanced - PTP Statistic

```
PTP STATISTIC
PTP state:          slave
PTP jitter:         0.25 us
PTP offset:         -0.03 us
PTP master to slave: 0s 5374ns
PTP slave to master: 0s 5319ns
Current PTP time (TAI): 1970-01-01 00:13:54
Current PTP time (TAI) (RAW): 834s 428775312ns
```

PTP state	Information about current PTP-clock state: initialize error deactivated receiving data pre master master passive not calibrated slave
PTP jitter	PTP-clock jitter in microseconds ( $\mu$ s)
PTP offset	Offset relative to PTP-clock master
PTP master to slave	Absolute offset master-to-slave in nanoseconds
PTP slave to master	Absolute offset slave-to-master in nanoseconds
Current PTP time (TAI)	Date and time information from GPS source*
Current PTP time (TAI) (RAW)	RAW TAI from GPS source*

\* Temps Atomique International- if no GPS source is available for PTP time-stamping, the date / time display starts at 1970-01-01 / 00:00:00 after every reboot of the device.

## Advanced - Network Advanced Settings

IGMP NIC 1	Definition or auto-select of IGMP version used to connect to a multicast router at NIC 1.
IGMP NIC 2	Definition or auto-select of IGMP version used to connect to a multicast router at NIC 2
TCP port HTTP	TCP port for HTTP
TCP port RTSP	TCP port for RTSP
TTL RTP packets	Time-To-Live of RTP packets- default: 128
DSCP RTP packets	DSCP marking of QoS of RTP packets- default: AF41
DSCP PTP packets	DSCP marking for QoS of PTP packets- default: CS6*
Multi stream rx	If activated, the device allows to subscribe to the same multicast stream more than one time- default: off
MDNS announcement	Announcement of streams via MDNS can be controlled to optimize network traffic or CPU load. Values: Off, RX, TX or RX/TX **
SAP announcement	Announcement of streams via SAP can be controlled to optimize network traffic or CPU load. Values: Off, RX , TX or RX/TX **
Multicast audio loopback	If activated, output streams (TX) can be subscribed (RX) by the device itself. Values: Yes, No
Multicast RTCP	Allows to disable RTCP for multicast streams. Values: Yes, No ***
Network settings Apply	Confirms and saves changes being made. Reboot required.

- \* AES67 specifies EF, but some implementations use EF for Audio streaming. To avoid overlapping of RTP and PTP packets in the same queue CS6 has been chosen as default.
- \*\* RX = receive, TX = transmit, RX/TX = receive and transmit
- \*\*\* RTCP is always active for unicast streams.

## NOTE



Source-Specific Multicast (SSM) support for IGMP v3, v2 and v1 (SSM via protocol only in IGMP v3, SSM via internal filtering is applied for IGMP v2 and v1) - see "Source Specific Multicast 1" on page 55.

## Advanced - PTP Jitter

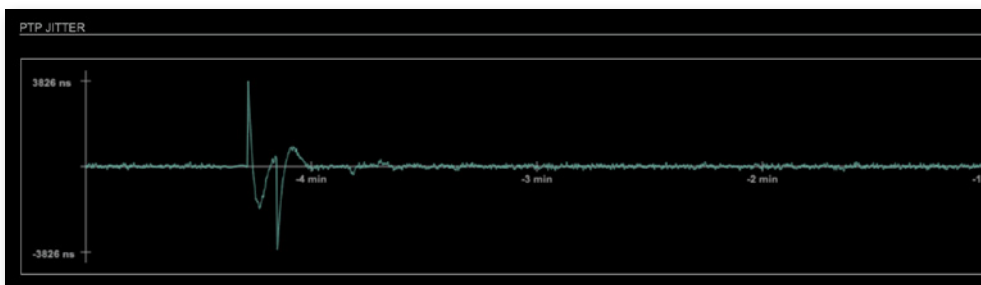

Graphical display of measured PTP jitter.

## NOTE



An error message next to Jitter measurement is displayed if delay requests are not being answered by Grandmaster.

## NMOS - Overview

The screenshot shows a web-based configuration interface for NMOS. At the top, there are navigation tabs: STATUS, MATRIX, EARS, ADVANCED, NMOS (selected), LOGGING, ABOUT, STATISTIC, SWITCH, and TOOLS. The main content area is divided into three sections: NIC1, NIC2, and ADDITIONAL SETTINGS. Each NIC section has fields for NMOS port, registry connection status, search mode, multicast, unicast DHCP, unicast, registry domain name, manually, registry IP address, registry port, and version. The ADDITIONAL SETTINGS section includes a checkbox for 'Disable stream during config', a 'Seed id' field, and a 'Generate new seed id' button. At the bottom, there are 'Apply' and 'Reset' buttons.

NMOS provides a family of specifications related to networked media for professional applications. It is developed and maintained by the Advanced Media Workflow Association (AMWA).

Support for NMOS is introduced with the AoIP Module version SW 0.17 / HW 0.46 according to the specifications:

- IS-04 Discovery & Registration (v1.3)
- IS-05 Device Connection Management (v1.1)

IS-04 allows control and monitoring applications to find the resources on a network. Resources include Nodes, Devices, Senders, Receivers, Sources, Flows...

IS-05 provides a transport-independent way of connecting Media Nodes.

More information: <https://specs.amwa.tv/nmos/>

### NMOS port - NIC1 & NIC2

The port entries for NIC1 and NIC2 are pre-configured by default. Modifications are possible but not necessary.

This close-up shows the 'NIC1' and 'NIC2' sections of the configuration interface. For NIC1, the 'NMOS port' field is set to '3210'. For NIC2, the 'NMOS port' field is set to '3212'.

NMOS port (NIC1 + NIC2)	Port address. Reboot required after modification.
----------------------------	---

## Search mode NMOS registry

Multicast	use mDNS to determine and connect to the registry server
Unicast DHCP	discovery on the DNS server (DNS-SD) using the domain given by DHCP
Unicast	discovery on the DNS server (DNS-SD) using a custom domain name
Registry domain name	custom domain name of the registry server
Manually	manual configuration of registry server
Registry IP address	IP address provided by network administrator
Registry port	Port provided by network administrator
Version*	Support of NMOS API version Values: v1.0, v1.1, v1.2, v1.3

\* registry versions are not backwards compatible.

### NOTE



DNS-SD uses the first returned entry and does not take priorities into considerations.



## NMOS - Additional Settings

Disable stream during config	Automatically disable and re-enable streams when settings are changed via NMOS (recommended)
Seed id	Unique identifier, subordered entities are derived from the seed id.
Generate new seed id Generate	Generates a new unique identifier. Reboot required.

NMOS uses a logical data model based on the JT-NM Reference Architecture to add identity, relationships and time-based information to content and broadcast equipment. Hierarchical relationships group related entities, with each entity having its own identifier.

The identifiers are persisted across restarts of the device in order to make them useful over a period of time longer than a single production deployment.

New identifiers may be generated manually if required.

This page is left blank intentionally.

## Logging



The tab 'LOGGING' displays logging depending on the 'Log Settings'. The logging can be enabled individually for different protocols, each of with an adjustable filter. An adjustable log level specifies the information detail of each entry.

To save a log the content of the view can be copied and pasted to a text document.

### Log Level

0	log data
1	level and log data
2	protocol, level and log data
3	protocol, process-id of requesting process, process-id of running process, level and log data
4	protocol, process-id of requesting process, process-id of running process, level, processor time in ticks and log data
5	protocol, process-id of requesting process, process-id of running process, level, processor time in ticks, file name and line and log data

**Protocol Types**

ARP	Address Resolution Protocol
BASE	Basic operation of module
DHCP	Dynamic Host Configuration Protocol
DNS	Domain Name System
FLASH	Process for updating the module
IGMP	Internet Group Management Protocol
MDNS	Multicast Domain Name System
NMOS	Network Media Open Specification
PTP	Precision Time Protocol
RS232	Serial Protocol
RTCP	Real Time Control Protocol
SAP	Session Announcement Protocol
TCP	Transmission Control Protocol
Zeroconf	Zero Configuration Protocol

**Log Filter**

NONE	logging disabled
ERROR	error occurred
WARNING	warnings- condition that may lead to unwanted behavior or an error
INFO 1	log info* + WARNING + error
INFO 2	log info* + WARNING + error
INFO 3	log info* + WARNING + error
INFO 4	log info* + WARNING + error

\* increasing amount of log info starting from ,INFO 1'

**Log Operation**

Save log	Downloads the current log entries to a text-file (log.txt).
Clear log	Deletes all log entries without further prompt.
Scroll lock	Interrupts automatic scrolling of the list view to allow copying the content to a text file via copy & paste. If scrolling is stopped for a longer period of time the display may not list all entries.

## Statistic

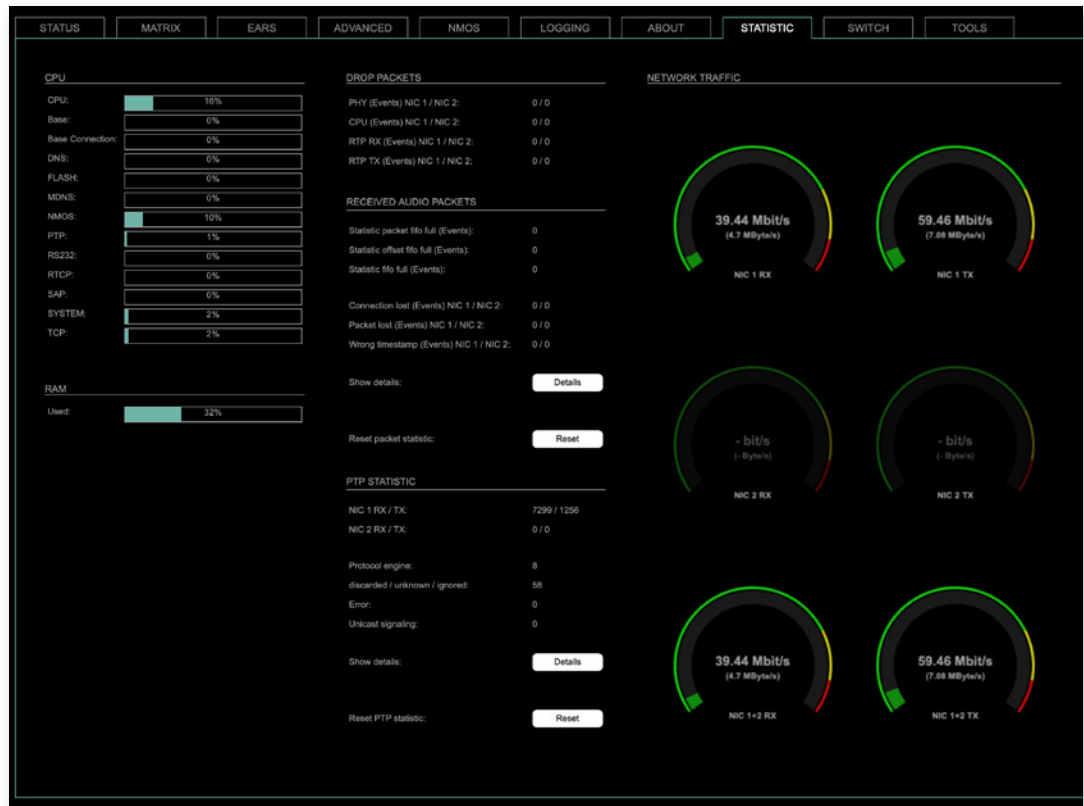

The tab 'STATISTIC' displays an overview of the CPU load of the particular processes, an error counter and a monitor display to indicate the incoming (RX) and outgoing (TX) network traffic on both network ports individually.

Details	Displays a list of input streams and related events (connection lost, packet lost, wrong timestamp) of received audio packets.
Reset	Resets the packet statistic

See „Protocol Types“ on page 87

## Switch

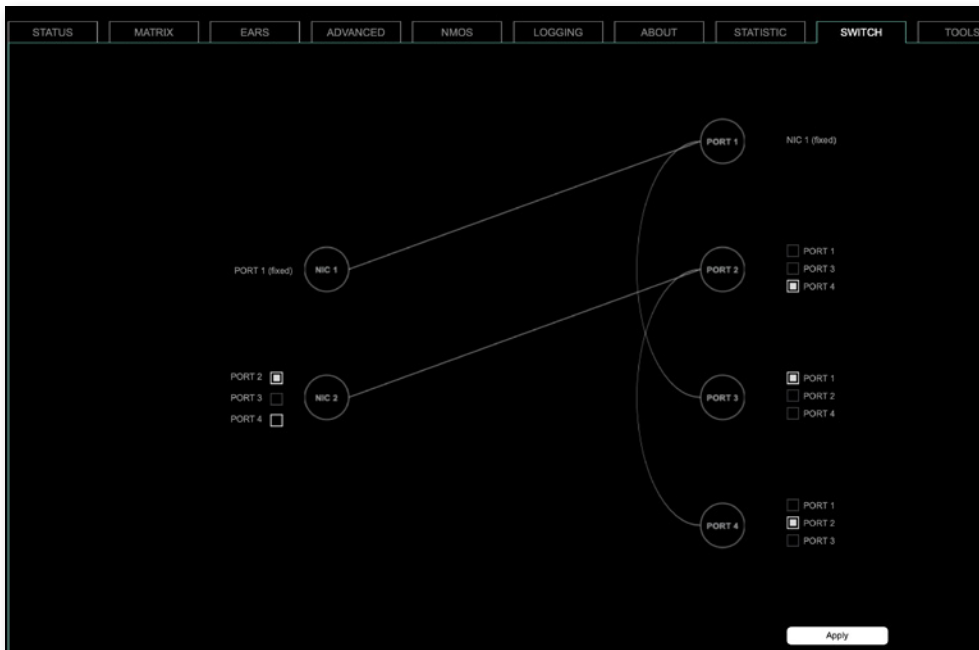

The device features four RJ45 sockets managed by two independent network interfaces (NIC 1 / NIC 2).

Port 1 is fixed assigned to NIC 1.

Port 2, 3 and 4 can be assigned to either NIC 1 or NIC 2 on the SWITCH tab

Factory default:

Port 1 = NIC 1 (192.168.0.1), Port 2 = NIC 2 (DHCP) - see page 40.

### NOTE



To access the module's control page it is required to connect the management network to one of the ports that is directly attached to a NIC - see next pages.

To give the very best PTP synchronisation performance, the switch incorporates advanced timestamping between the external PORTS and the internal NICs. As a consequence, the on-board switch cannot be used to connect other PTP devices via a single shared connection to the wider network.

Please connect all other PTP devices directly to your system's network switch.

### NOTE



If NIC 1 and NIC 2 are connected to the same switch, they must be configured to different subnets - see "Network Settings" on page 40.

## Tools

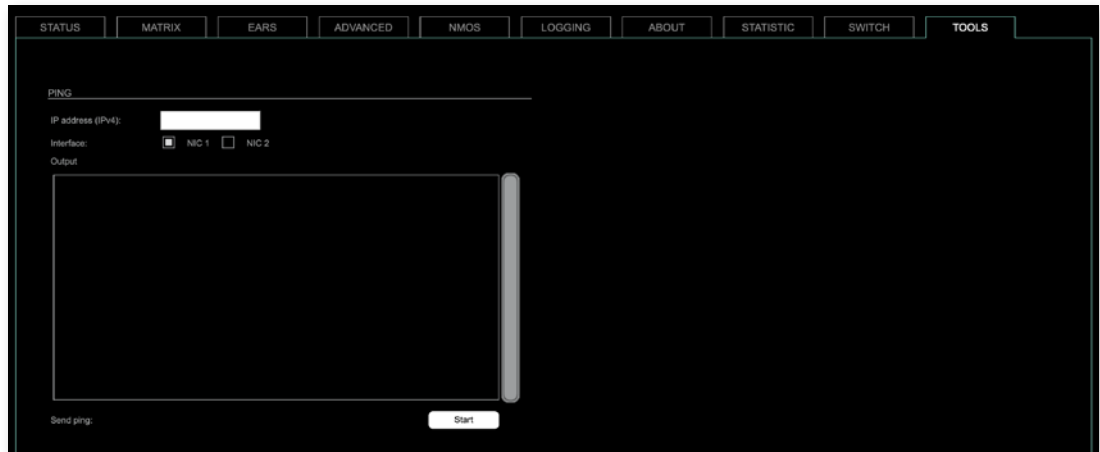

The tab 'TOOLS' offers a generator to ping any IP address (IPv4) from either NIC 1 or NIC 2. The result is displayed at the 'Output'.

IP address (IPv4)	Enter IP address (IPv4) to be pinged
Interface	Select NIC 1 or NIC 2
Start	Sends ping to the specified IP address from selected NIC.

This page is left blank intentionally.



**SWITCH - Configurations (exemplary)**

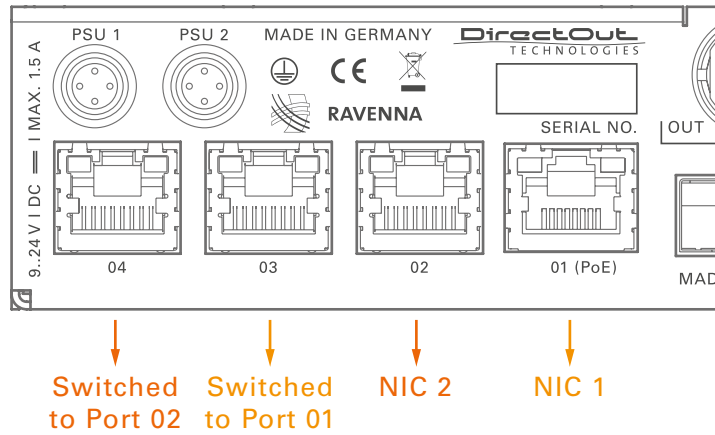

RAVENNA Audio & Control via Port 1 and Port 2  
Extra ethernet traffic via Port 3 (NIC 1) and Port 4 (NIC 2)  
Default Setting

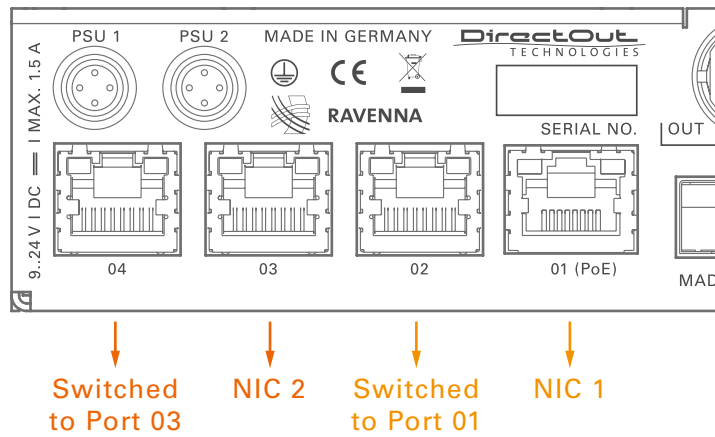

RAVENNA Audio & Control via Port 1 and Port 3  
Extra ethernet traffic via Port 2 (NIC 1) and Port 4 (NIC 2)

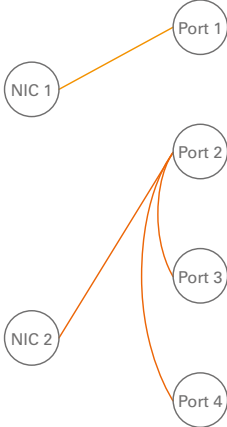
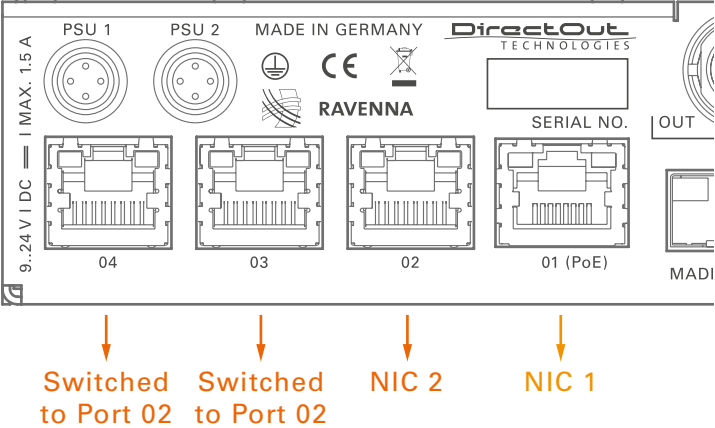

RAVENNA Audio & Control via Port 1 and Port 2  
Extra ethernet traffic via Port 3 (NIC 2) and Port 4 (NIC 2)

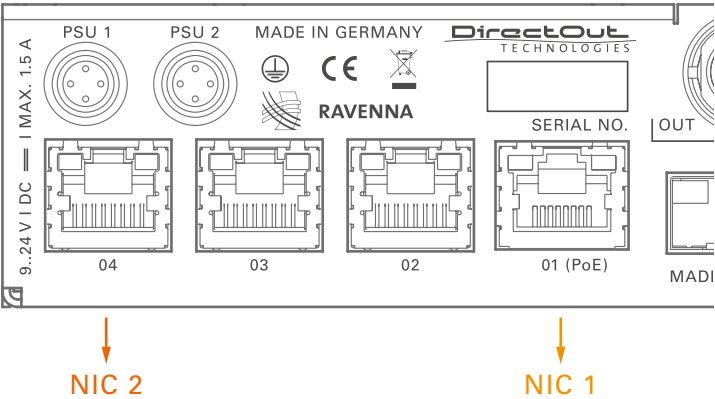

RAVENNA Audio & Control via Port 1 and Port 4  
Port 2 and Port 3 not active.

## CHAPTER 6: Troubleshooting and Maintenance

### Troubleshooting

To identify a possible defect with the device please consult the following table. If the fault cannot be resolved using these instructions, please contact your local DirectOut representative or visit [support.directout.eu](http://support.directout.eu).

Issue	Possible reason	Solution
Device doesn't work.	Power supply is broken.	Check that the power supply switch is on, that the device is connected to the power supply and that the socket is working. Defective fuses must be exchanged by qualified service personal only.
Optical port does not work.	Optic is dirty.	Use an air supply to carefully remove any dust. Never use objects for cleaning.
No signal at the output port.	Connections (input / output) are mixed up.	Check the connections and change the cables if necessary. Check the routing matrix.
No signal at the output port.	Signal cable defective.	Exchange the signal cable.
No signal at the output port.	Connectors of the signal cable are dirty.	Use an air supply to carefully remove any dust. Never use objects for cleaning. or Exchange the signal cable.
MADI signal at the input is not stable.	Signal source is defective or bad signal condition (Jitter > 1 ns)- e.g. due to exceeded length or bad screening attenuation of signal cable.	Change the source or use appropriate cables.
LED PTP blinking red	NET I/O not in sync with the device's clock source	Sync to PTP or Enable FastSRC™

## Maintenance

To clean the device, use a soft, dry cloth. To protect the surface, avoid using cleaning agents.

### NOTE

---

The device should be disconnected from the power supply during the cleaning process.



## CHAPTER 7: Technical Data

### Dimensions

- Width 140 mm
- Height 42 mm
- Depth 146 mm

### Weight

- 0.7 kg

### Power Consumption

- 9 W (typical)

### Power Supply

- 2 x Hirose socket (HR10)
- 9 V- 24 V DC (external)



---

## WARNING!

The connected power supply must provide a current limiting to a maximum of 2.5 A.

### Environmental Conditions

- Operating temperature +5°C up to +45°C
- Relative humidity: 10%- 80%, non condensing

### MADI Ports SC optical

- SC socket FDDI (input / output)
- ISO/IEC 9314-3
- Wave length 1310 nm
- Multi-Mode 62.5/125 or 50/125

### MADI Ports BNC coaxial

- BNC socket (input / output)
- Impedance: 75  $\Omega$
- 0.3 V up to 0.6 V (peak to peak)

### MADI Ports SFP

- empty cage without module

### Sample Rate

- 30 - 50 kHz @ 1 FS
- 60 - 100 kHz @ 2 FS
- 120 - 200 kHz @ 4 FS

**MADI Format (I/O)**

- 48k Frame, 96k Frame
- 56 channel, 64 channel

**Network**

- 4 x RJ45 socket
- Gigabit Ethernet
- for transmission of network audio, control data and firmware updates
- Network-Layer 3
- 32 streams
- 64 channels I/O @ 1 FS (32 ch @ 2 FS, 16 ch @ 4 FS)
- Standard: RAVENNA, AES67, ST 2110-30 /-31, ST 2022-7

**PoE (Network Port 1)**

- PoE Class 0 / 0.4 - 13W
- IEEE 802.3af

**Sample Rate Conversion**

- FastSRC™ @ NET I/O (RAVENNA)
- Latency: less than 0.15 ms @ all scaling factors

## Appendix A - Wiring Sketches

### Hirose HR10 (DC PSU)

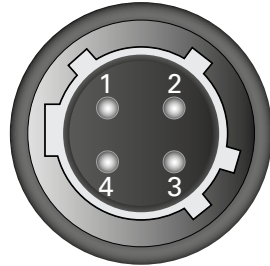

Pin	Signal
1	DC +
2	DC +
3	DC -
4	DC -



#### NOTE

To ensure proper operation all pins should be connected.



#### NOTE

Ground is connected with the chassis of the plug (safety class 1).

## Appendix B - Working with BLDS™

### Introduction

The Buffer Loop Detection System™ is used to detect silence or a corrupted input signal- e.g. caused by an application hang of the playout system (repeating buffers) or stuttered playback due to system overload.

A BLDS™ generator creates a .wav file containing a low levelled signal which is inserted into the MADi stream. The artificial design of the BLDS™ signal enables reliable and inaudible switch-over within one sample.

### BLDS™ Generator

The application is available for Windows® and OS X®.

1. Download the application at [www.directout.eu](http://www.directout.eu)
2. Unpack the zip archive and open the 'BLDS\_Generator.exe' (Windows®) or 'BLDS Generator.app' (OS X®).

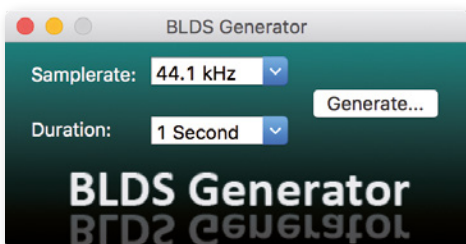

3. Define sample rate and duration using the drop down menus.

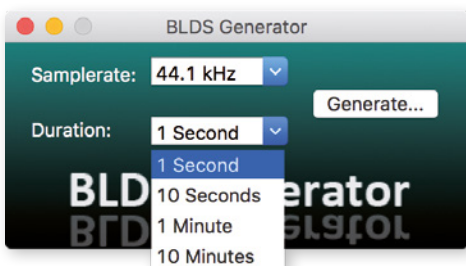
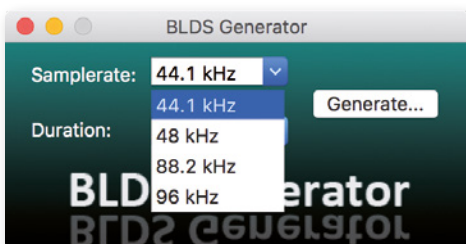



- Click 'Generate' to save the a 24 bit mono .wav file with the settings specified.



## NOTE

The BLDS™ signal is designed so that it is 16 bit safe and the level is below -60 dBFS.

- A 'Save as' dialogue appears. Store the file to your preferred location.

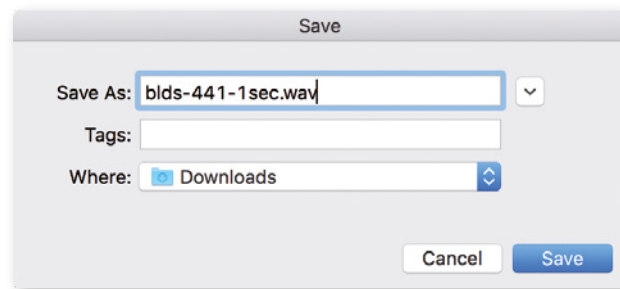

- Import the .wav file into an audio session of your DAW. The BLDS™ signal needs to be present in the audio channel that is monitored by the triggered switch.



## NOTE

When duplicating the signal in the timeline carefully check that there are no gaps, crossfades or overlaps at the boundaries. This violates the BLDS™ condition resulting in possibly unwanted behaviour.

## Appendix C - Working with ch 57 mode

Channel mode 57 ch on the MADl output enables transparent pass-through of embedded control data that is used by DiGiCo consoles.

Ch 57 mode is detected at the MADl input automatically and signaled to the user.

To preserve the control data throughout the signal chain:

- set MADl output to 57 ch mode
- route input channel 57 to output channel 57

The control data is preserved also across a RAVENNA connection to another EXBOX.RAV, where it is output to MADl.

### **NOTE**

---



The incoming control data is neither examined nor altered by the device.

## Appendix D - Firmware Update

The device is updated via network.

The firmware update will update EXBOX.RAV and the AoIP module.

Visit [www.directout.eu](http://www.directout.eu) and navigate to the EXBOX.RAV product page.

Download:

- EXBOX.RAV Firmware

Open the control page of the module and navigate to the tab STATUS and click SETTINGS in the top right corner (p 44).

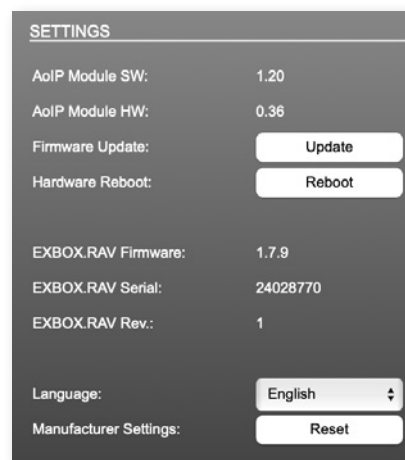

Click 'Update' and browse to the update file after unzipping first.

Example: `exbox_rav_fw_179_hw_0_36_sw_1_20.update`

Follow the instructions displayed.



### **WARNING!**

Power-cycle the device after the firmware update to initialize properly.



### **WARNING!**

It is strongly recommended to backup the device configuration (Save Preset) before running any update.

This page is left blank intentionally.

## Index

### A

Accessory	
BOXMOUNT.XL .....	16
SFP Transceiver- MADI .....	15
AES67 .....	59

### B

Backup Streams.....	48
BLDS™ .....	68
generating .....	99
BMCA .....	74
BOXMOUNT XL.....	16

### C

Channel Mode 57 ch .....	101
Clocking	
Options .....	25
Preferred master.....	25
Word Clock.....	27, 38
Conformity & Certificates	
CE .....	13
RoHS .....	13
WEEE .....	13
Contact .....	13
Contents .....	14
Conventions.....	5

### D

Defective Parts/Modules .....	10
DigiCo .....	101
Dimensions.....	96
Direct routing.....	41
Discovery .....	53

### E

Environmental conditions .....	17, 96
--------------------------------	--------

### F

FastSRC .....	26, 34
Firmware Update.....	102
First Aid .....	11
Force (EARS).....	69

### G

globcon control .....	14
GMID .....	39
Grant duration.....	75

### H

Hybrid Mode.....	73
------------------	----

### I

Intended Operation.....	12
IP Address	
default.....	18
modify .....	40
IP Mode	
Hybrid .....	73
Multicast.....	73
Unicast .....	73
IS-04 see NMOS	
IS-05 see NMOS	

### L

Language .....	44
Logging.....	86

### M

MADI formats.....	7
-------------------	---

### N

Naming Input Stream.....	55
Network Configuration	
default.....	32
modify .....	40
Network Monitor .....	88
NIC.....	89
NMOS.....	82

---

<b>O</b>	
Offset .....	52
Offset <> Packet time .....	50
<b>P</b>	
Patching .....	63
Pilot tone .....	68
PoE Class .....	97
Power supply .....	7
Preset .....	45
PSU Reset .....	42
PTP	
Jitter .....	81
Modes .....	74
Profile .....	38
<b>R</b>	
RAV2 module state .....	29
Remote Control .....	14
Reset .....	44
<b>S</b>	
Sample Rate Conversion .....	26
FastSRC™ .....	26
Sample rates .....	7
Scaling Factor .....	21
Session Description Protocol .....	60
SFP Transceiver .....	15
Sketch	
Hirose HR10 (DC PSU) .....	98
Source Specific Multicast .....	55
ST 2110-30 .....	59
Stream input .....	51
name .....	55
Support .....	94
Switch- Configuration .....	92
<b>T</b>	
Technical data .....	96
Troubleshooting .....	94
<b>U</b>	
Unicast Mode .....	73
Unicast Stream .....	61
Updates .....	12
<b>W</b>	
Warranty .....	12
Word Clock .....	25

**DirectOut GmbH**

Hainichener Str. 66a  
09648 Mittweida  
Germany

T: +49-3727-5650-00  
M: [info@directout.eu](mailto:info@directout.eu)  
[www.directout.eu](http://www.directout.eu)